



Grand Prix Paris 1900.



Grand Prix Paris 1900.

Werkstätten

für

Präcisions-Mechanik und -Optik

von

Hans Heele

BERLIN O. 27

**Abbildungen der
Instrumente
und Apparate.**

Fernsprecher Amt VII a, 7788.

Tab. I.

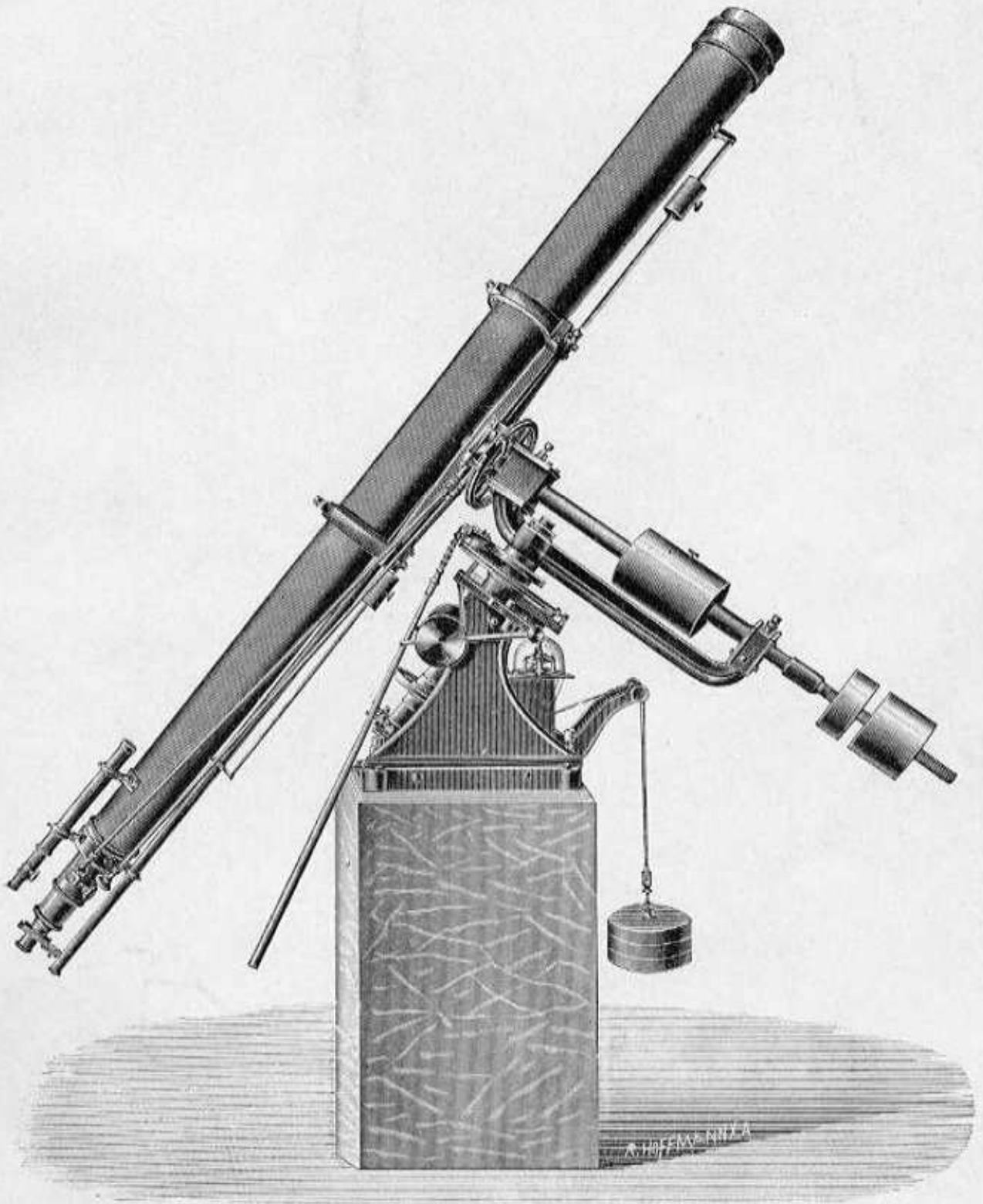

Catalog No. 4.

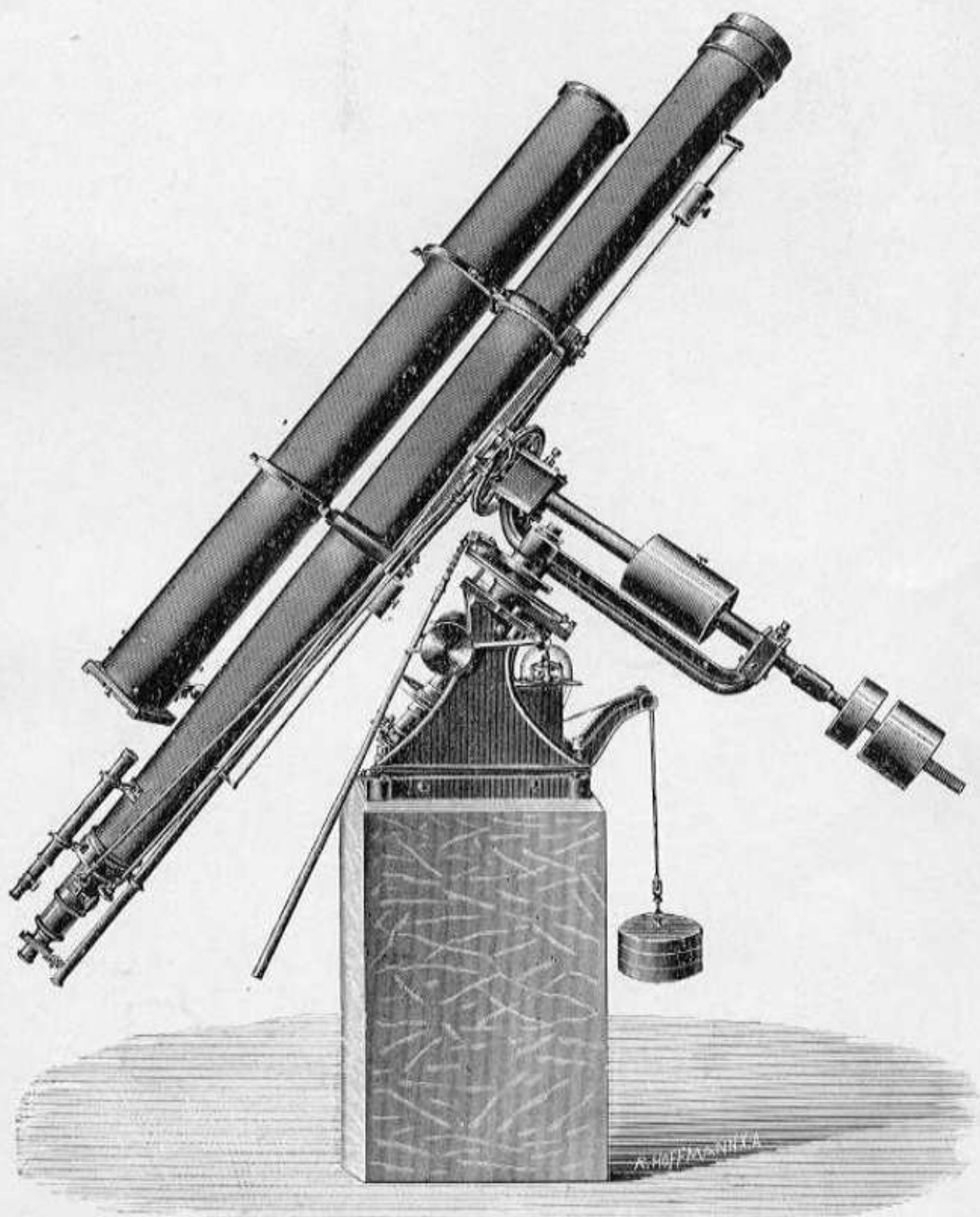

Catalog No. 14.

Tab. IV.

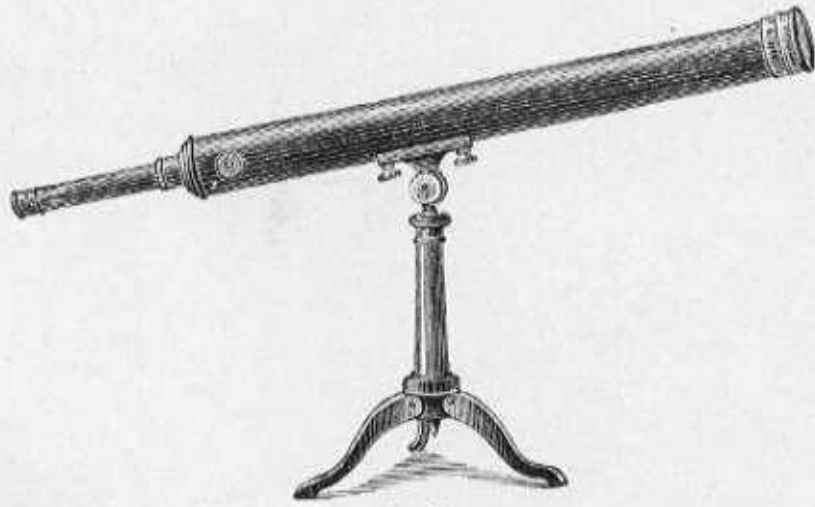

No. 1.
Catalog No. 22.

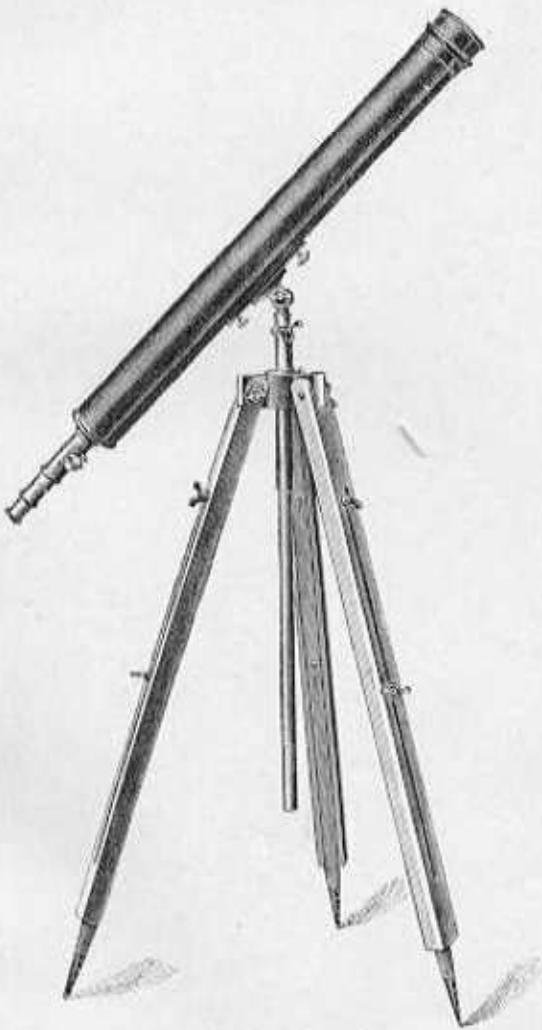

No. 2.
Catalog No. 25.

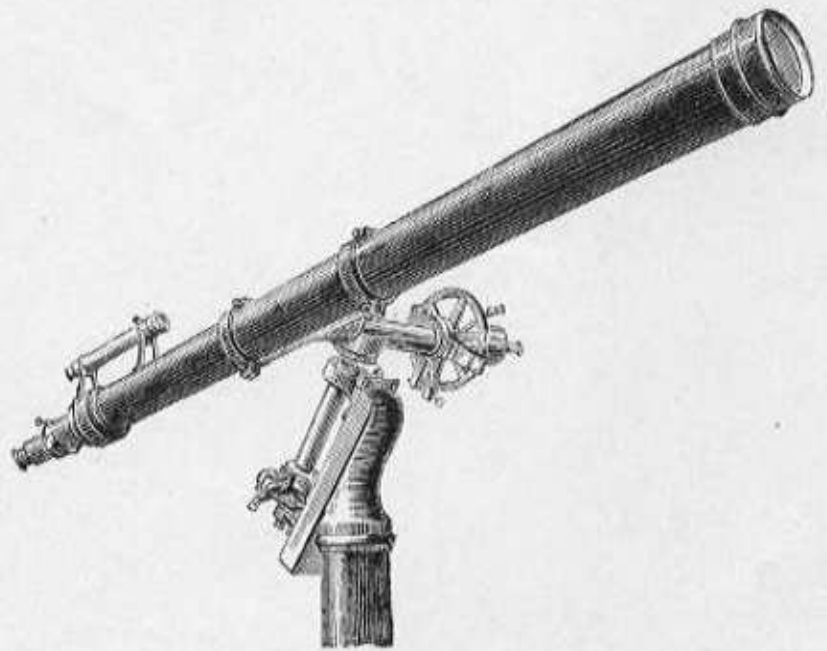

No. 3.
Catalog No. 16.

Tab. VI.

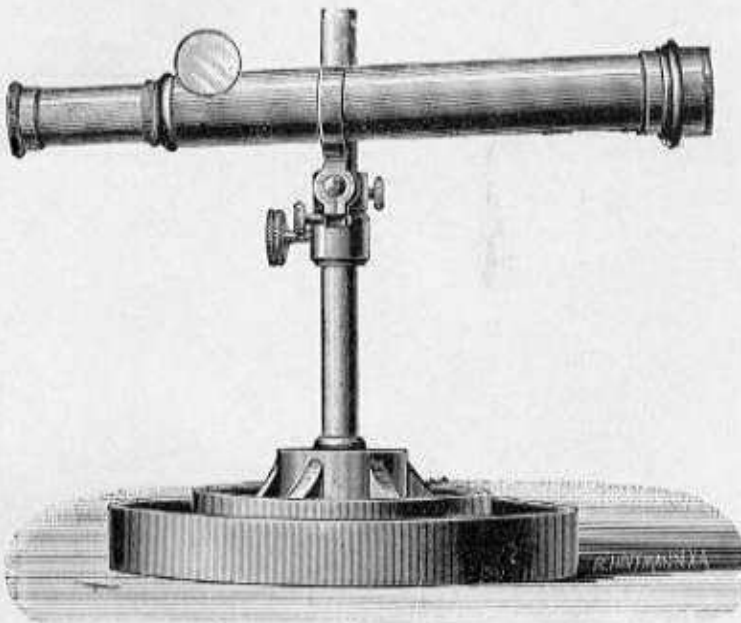

No. 1.
Catalog No. 104.

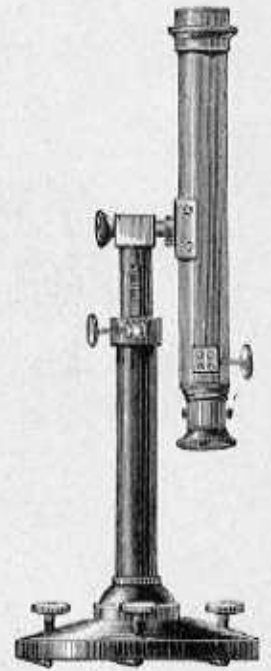

No. 2.
Catalog No. 93.

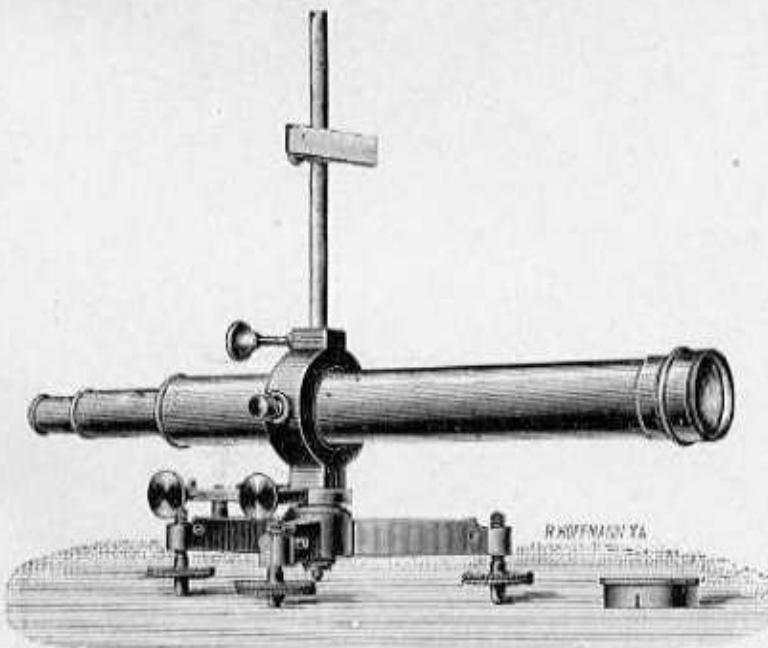

No. 3.
Catalog No. 99.

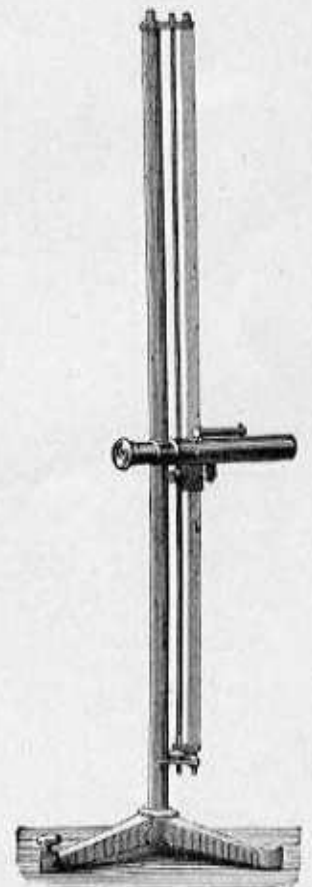

No. 4.
Catalog No. 89.

Tab. VII.

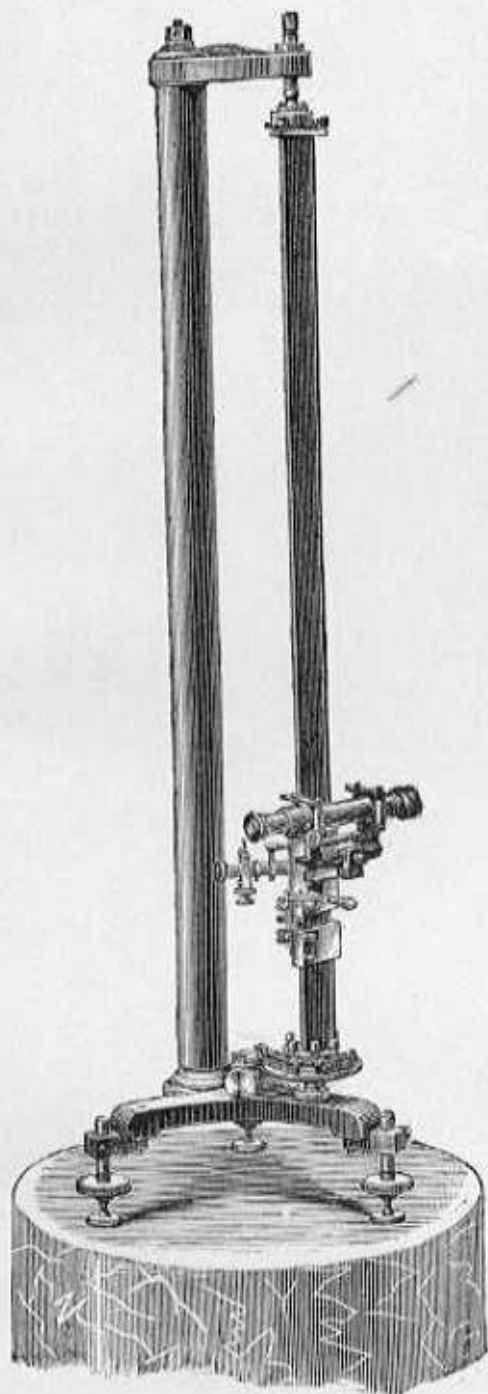

No. 1.
Catalog No. 114.

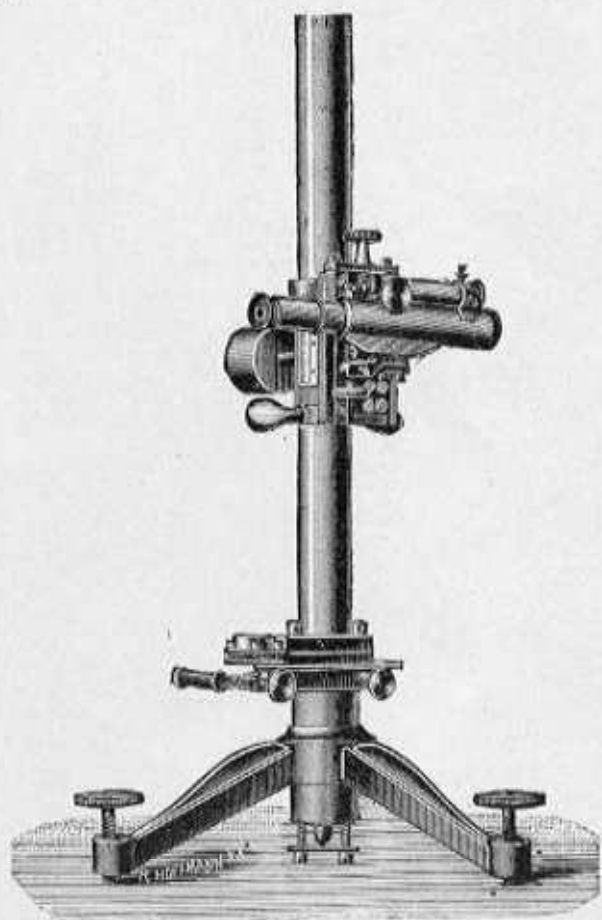

No. 2.
Catalog No. 115.

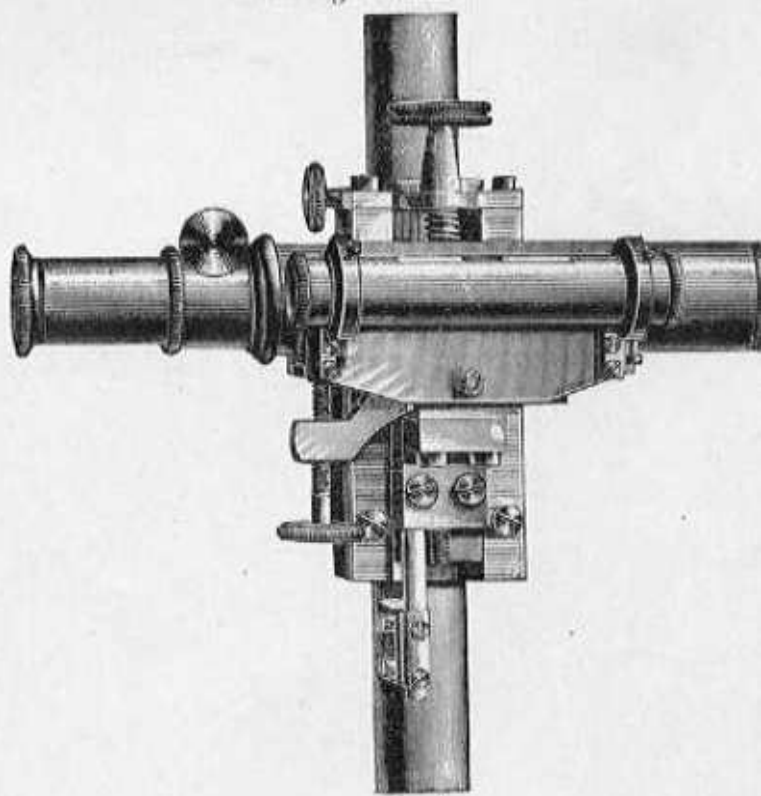

No. 3.
Catalog No. 115.

Tab. VIII.

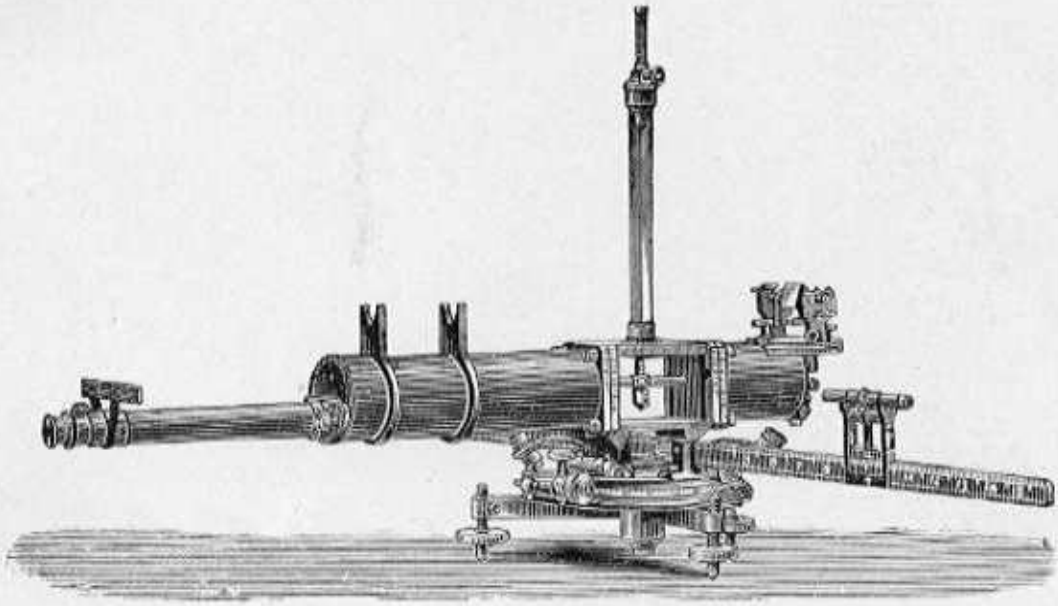

No. 1.
Catalog No. 117.

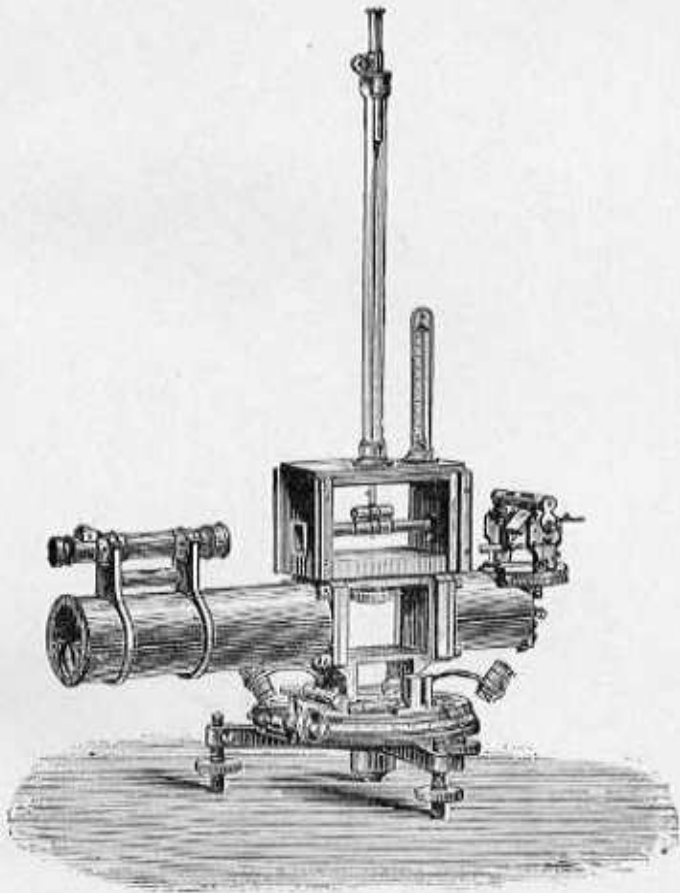

No. 2.
Catalog No. 117.

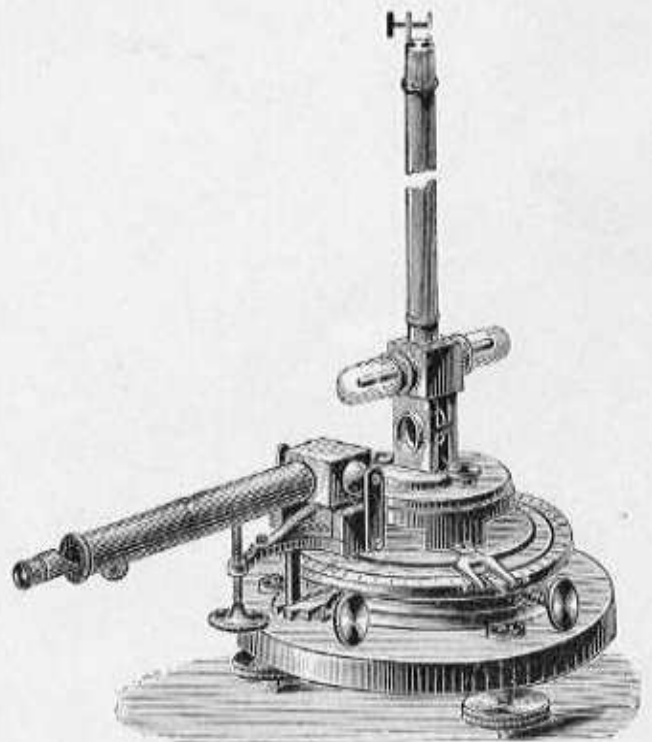

No. 3.
Catalog No. 118.

Tab. X.

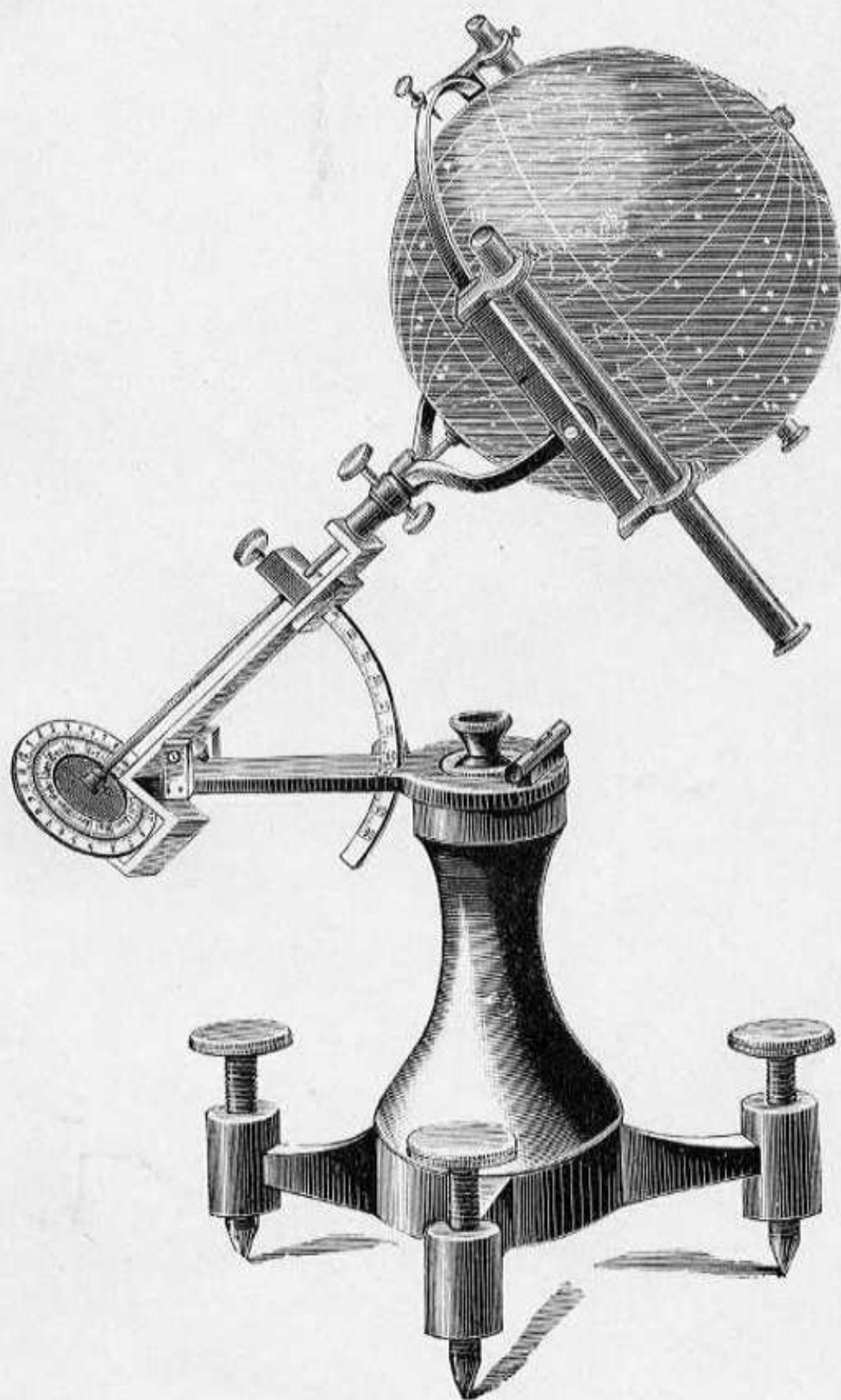

Catalog No. 298.

Tab. XI.

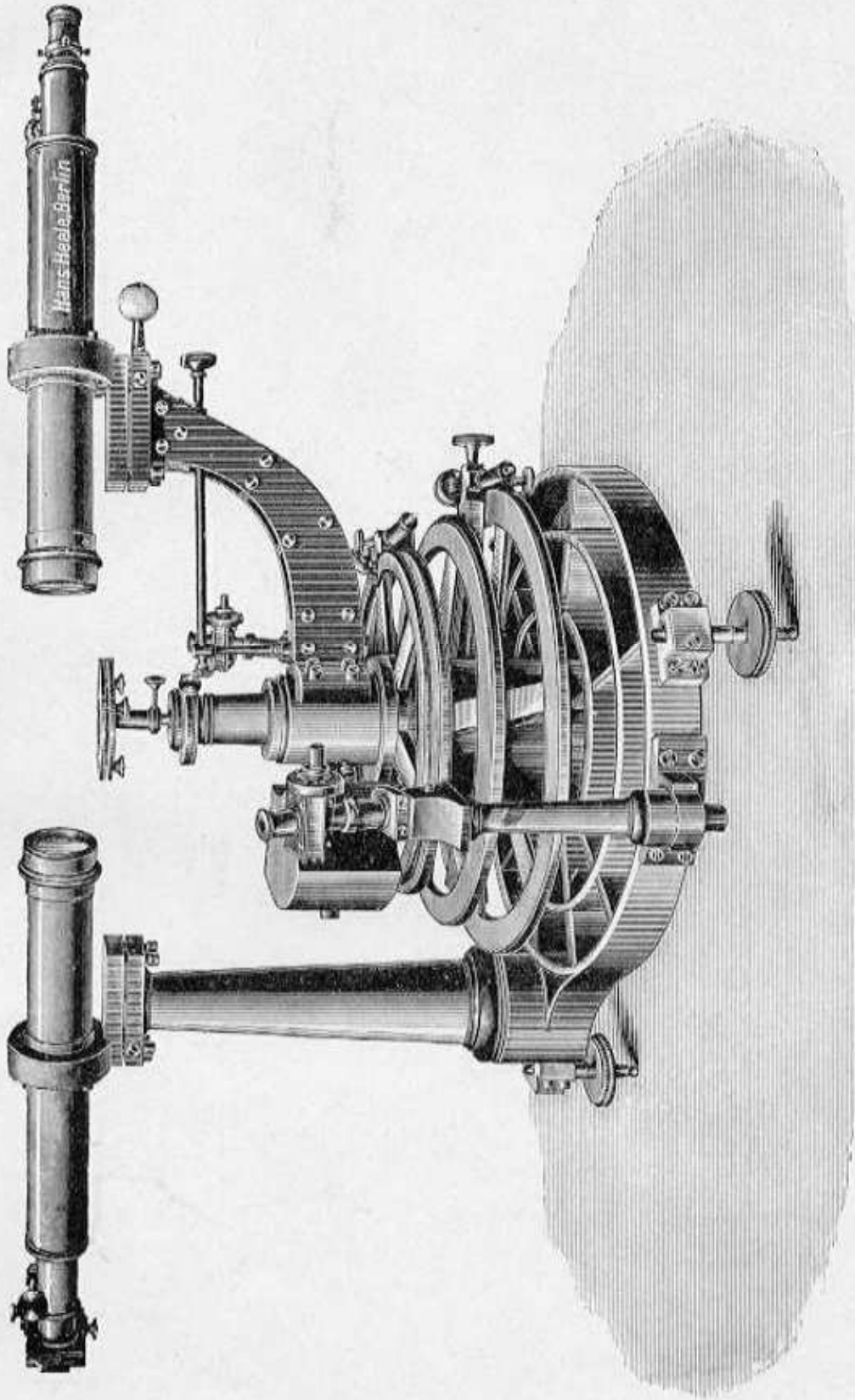

Catalog No. 213.

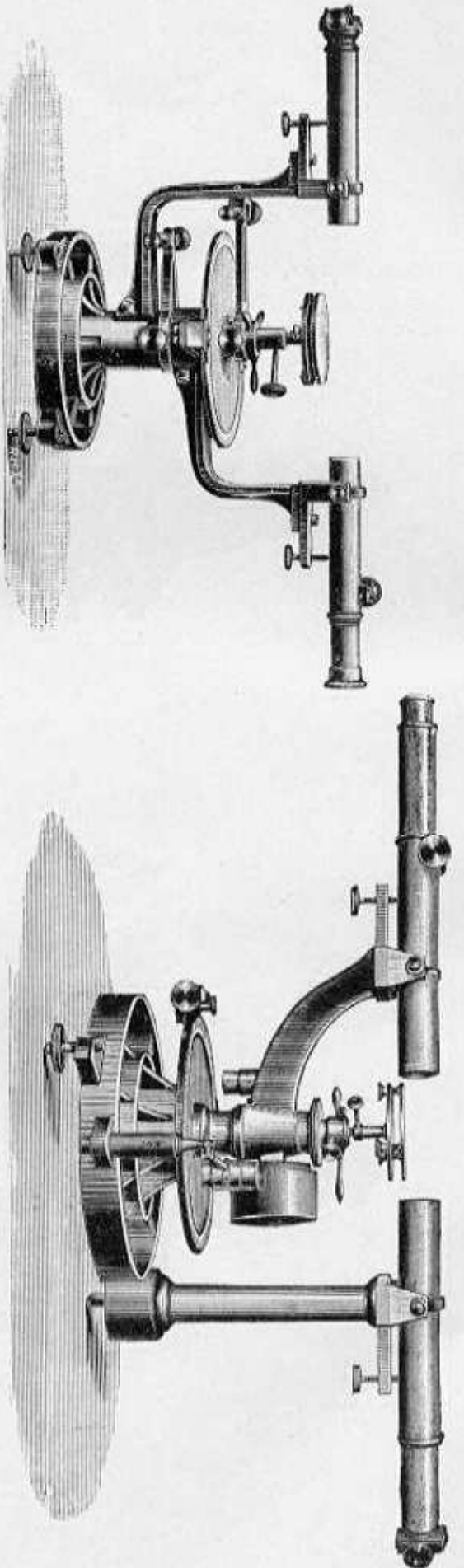

No. 1.

Catalog No. 218.

No. 2.

Catalog No. 216.

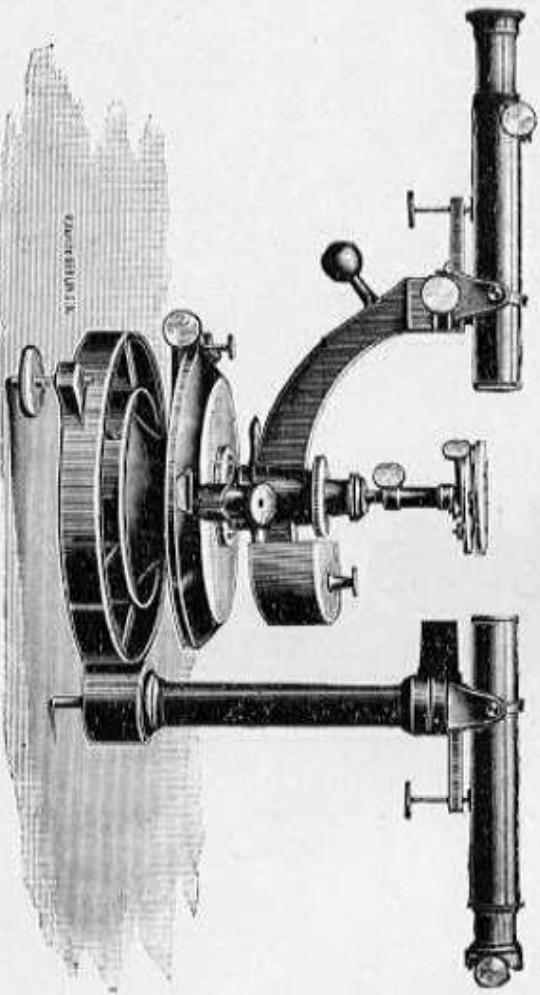

No. 3.

Catalog No. 217.

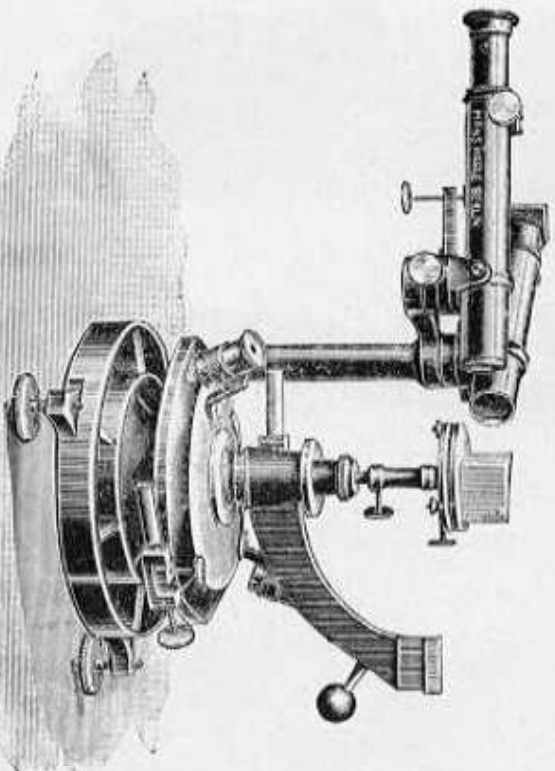

No. 3a.

Catalog No. 217.

Tab. XIII.

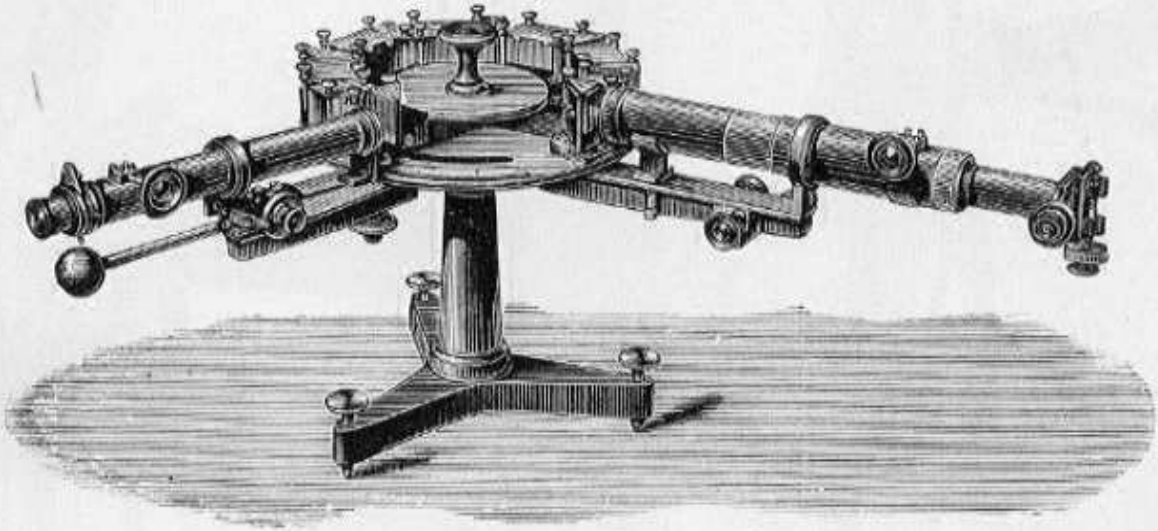

No. 1.
Catalog No. 138.

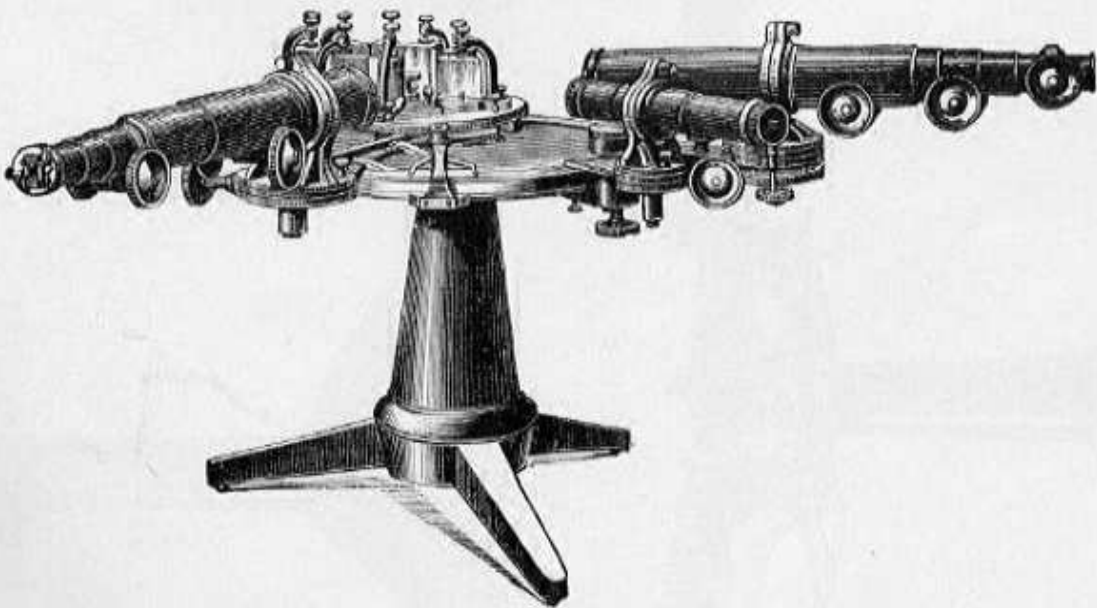

No. 2.
Catalog No. 141.

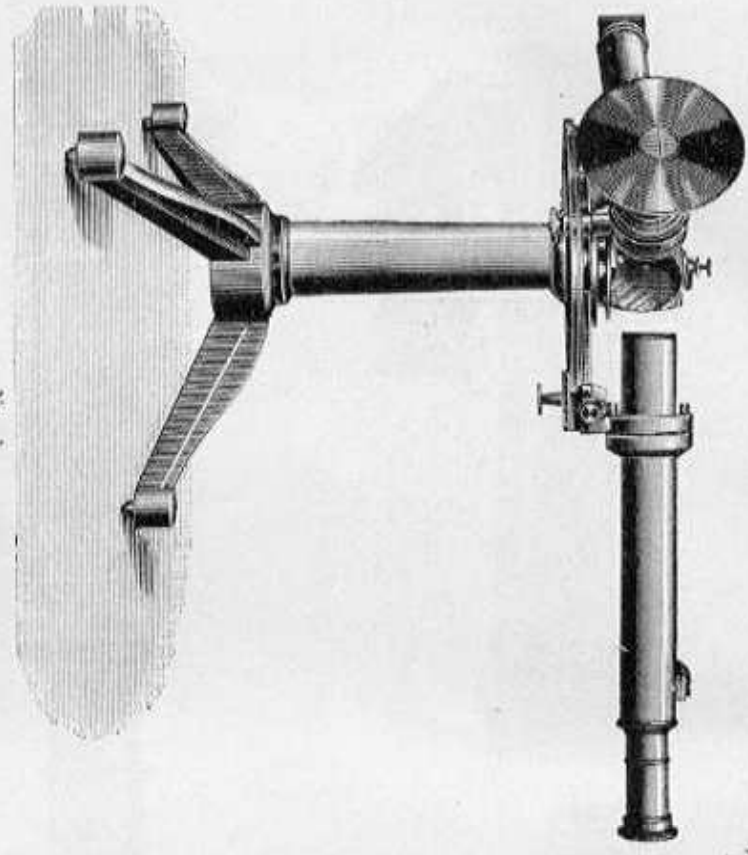

No. 1.
Catalog No. 148.

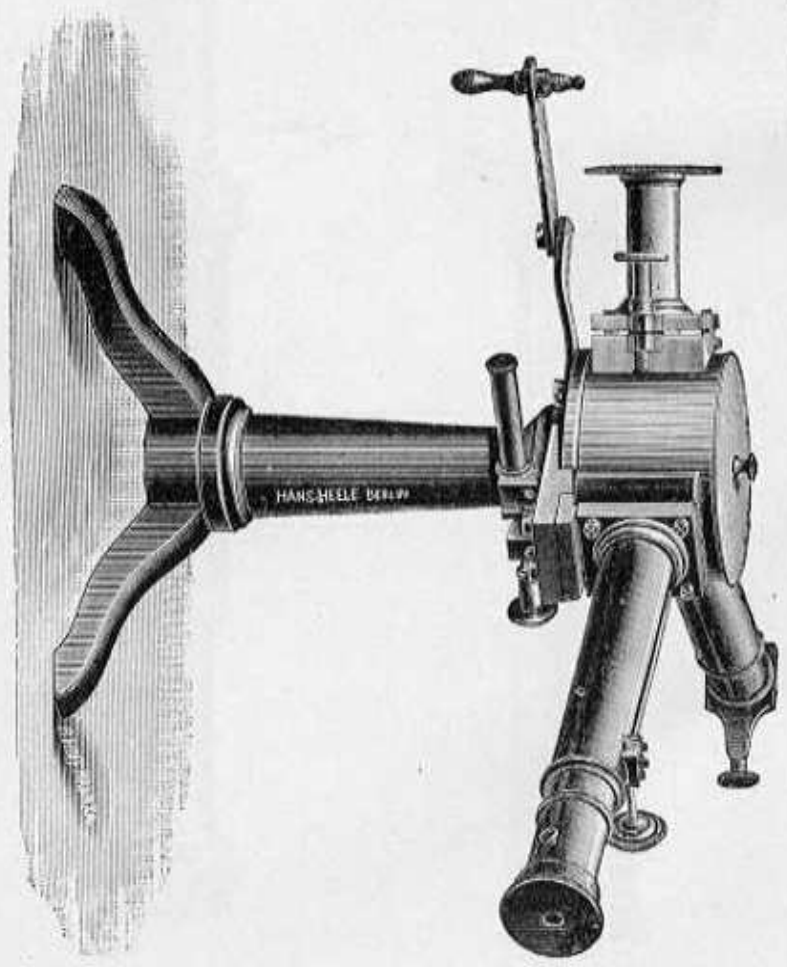

No. 3.
Catalog No. 150.

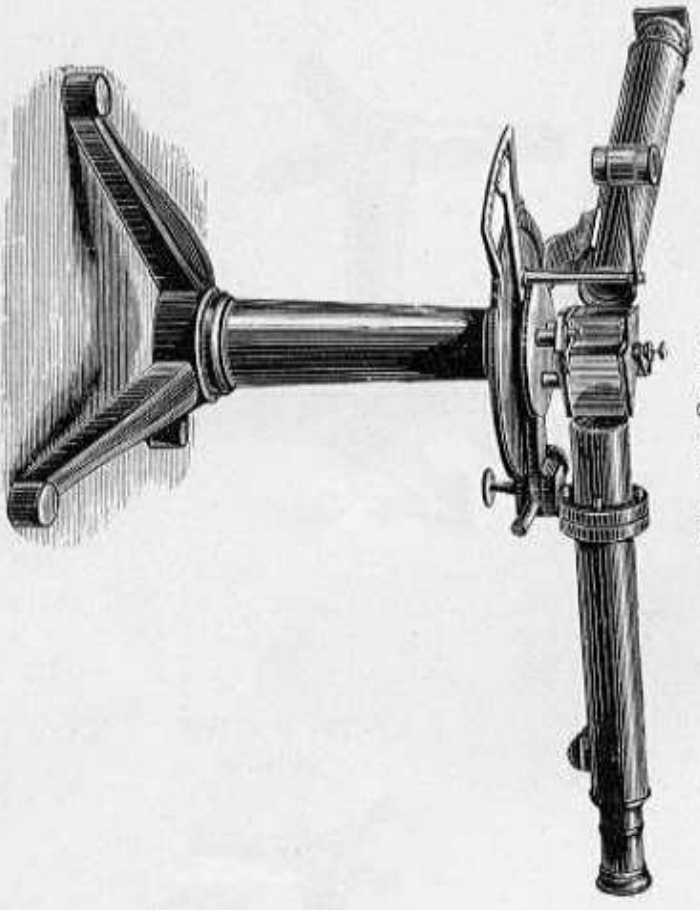

No. 2.
Catalog No. 145.

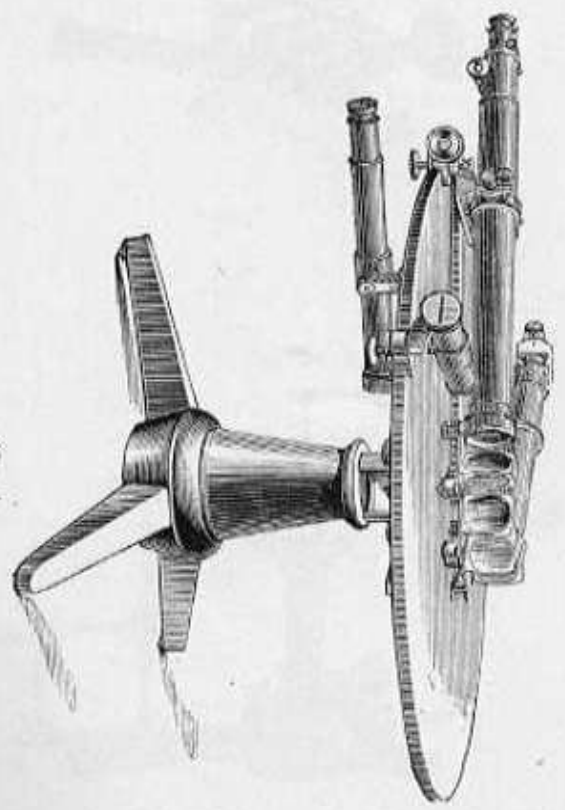

No. 4.
Catalog No. 142.

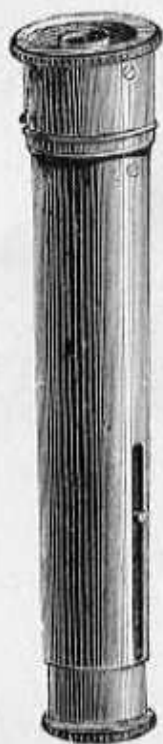

No. 1.

Catalog No. 167.



No. 3.

Catalog No. 164.

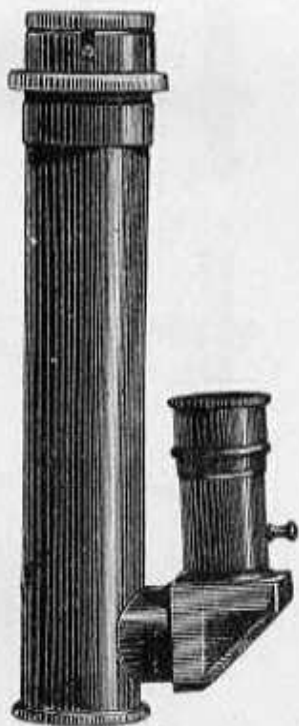

No. 2.

Catalog No. 168.

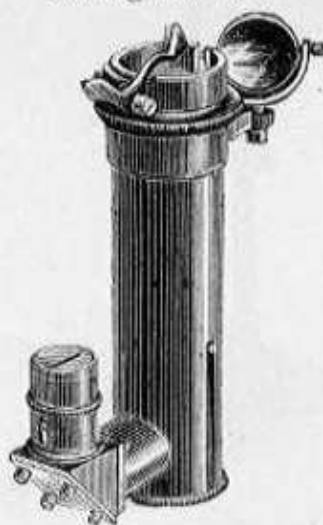

No. 4.

Catalog No. 174.

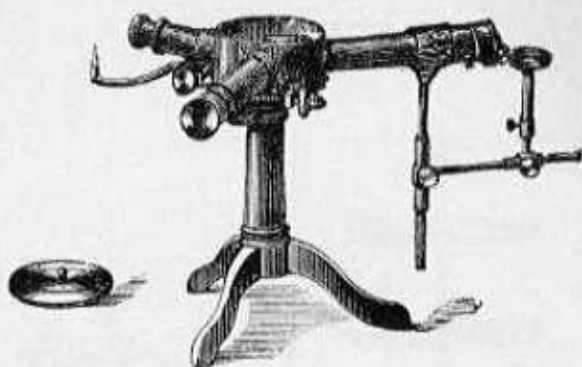

No. 5.

Catalog No. 151.



No. 6.

Catalog No. 155.

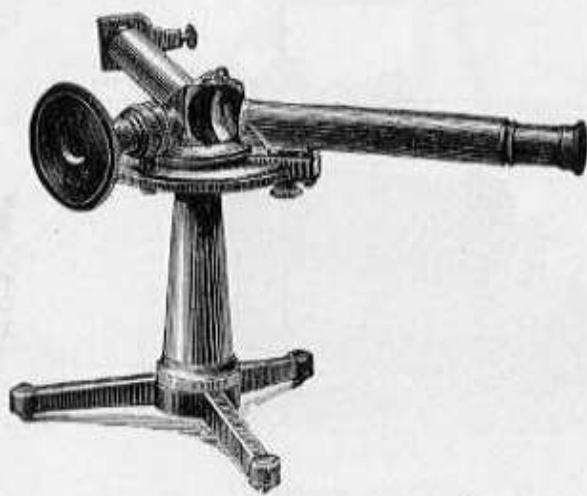

No. 7.

Catalog No. 149.

Tab. XVI.



No. 1.
Catalog No. 161.

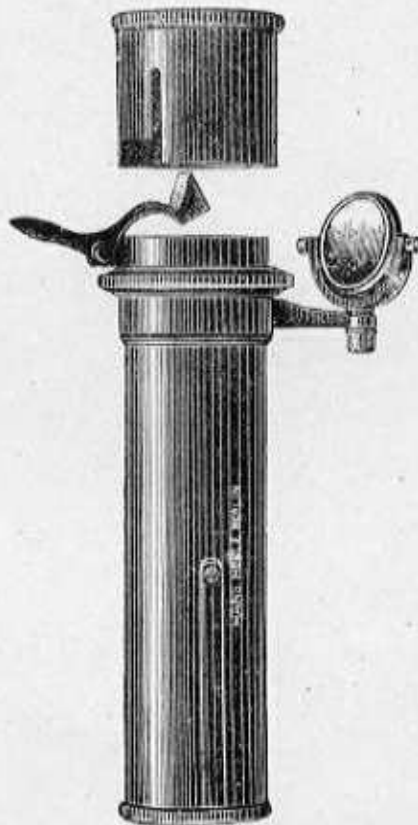

No. 2.
Catalog No. 175.

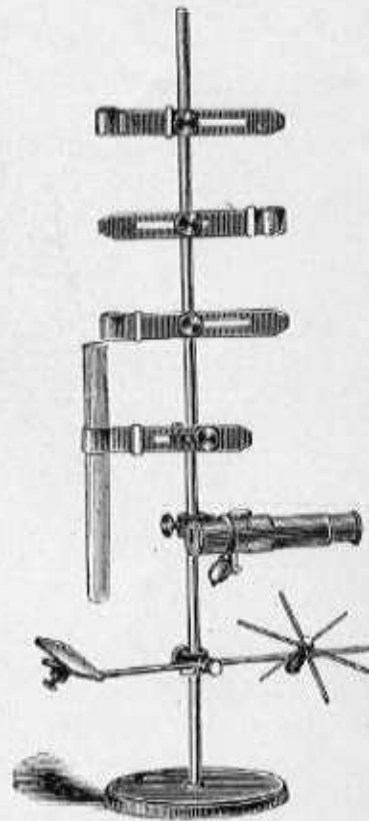

No. 3.
Catalog No. 176.

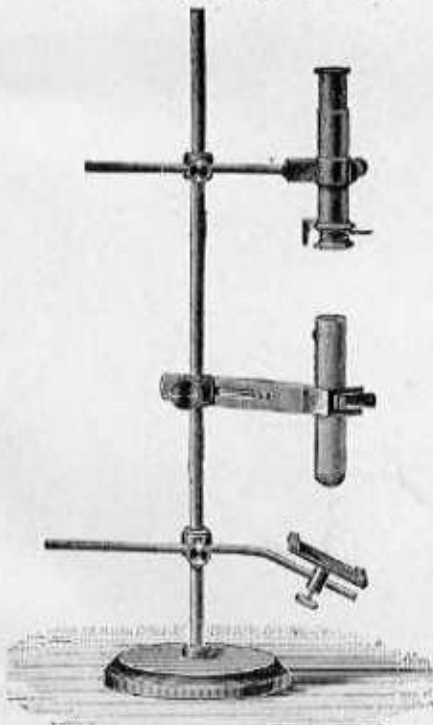

No. 4.
Catalog No. 176.

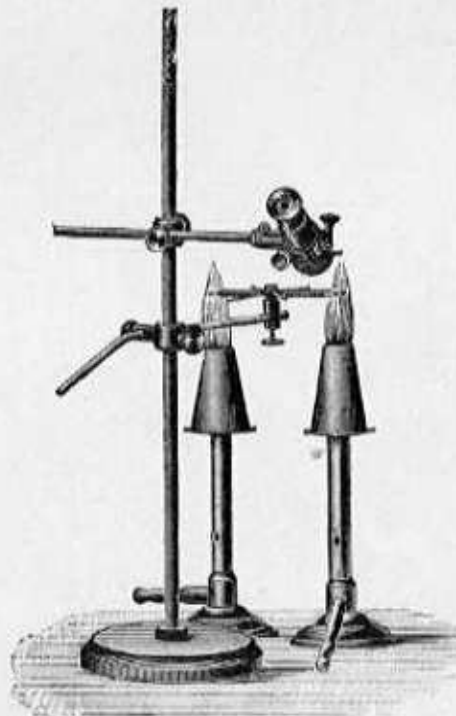

No. 5.
Catalog No. 176.

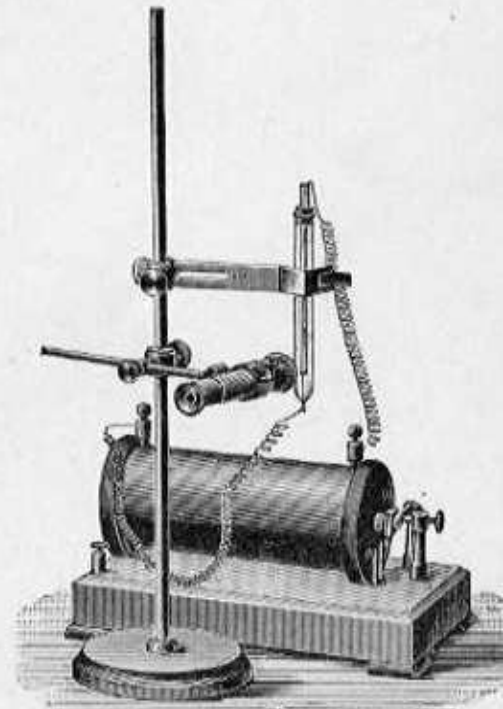

No. 6.
Catalog No. 176.

Tab. XVII.

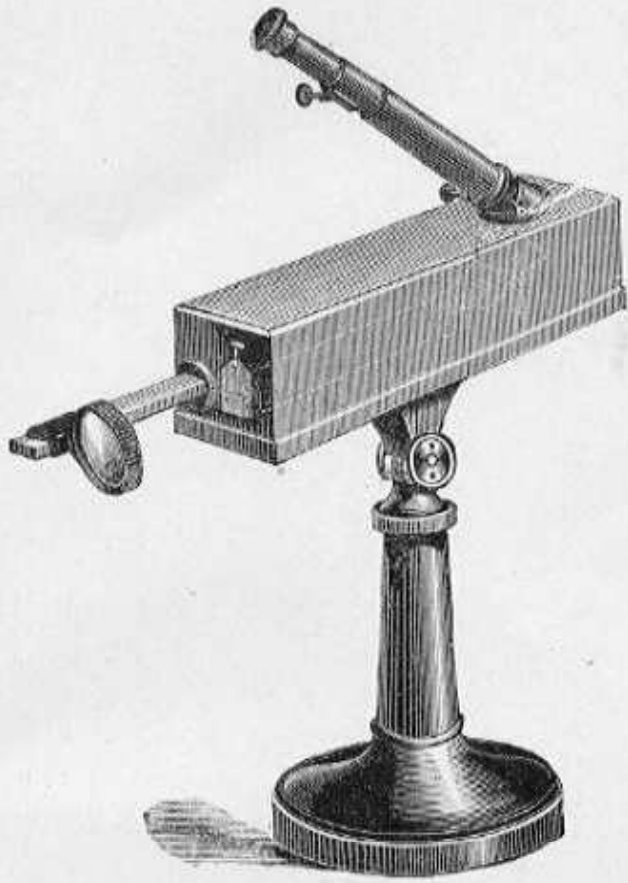

No. 1.
Catalog No. 182.

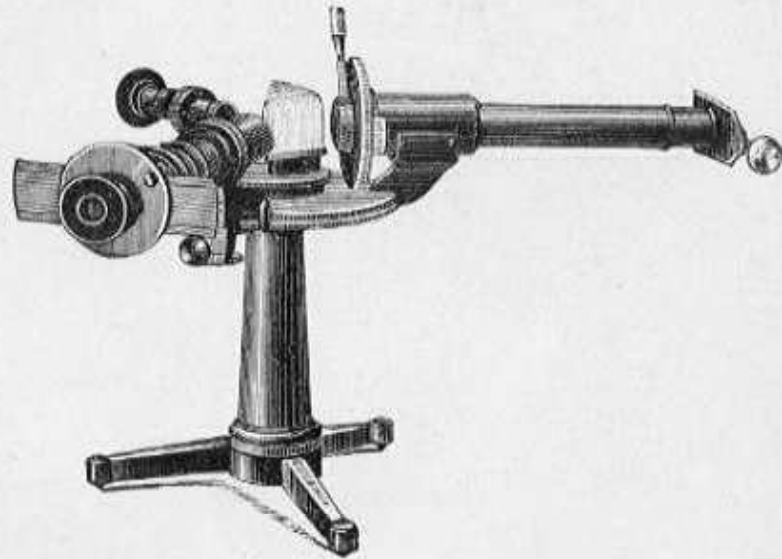

No. 2.
Catalog No. 179.

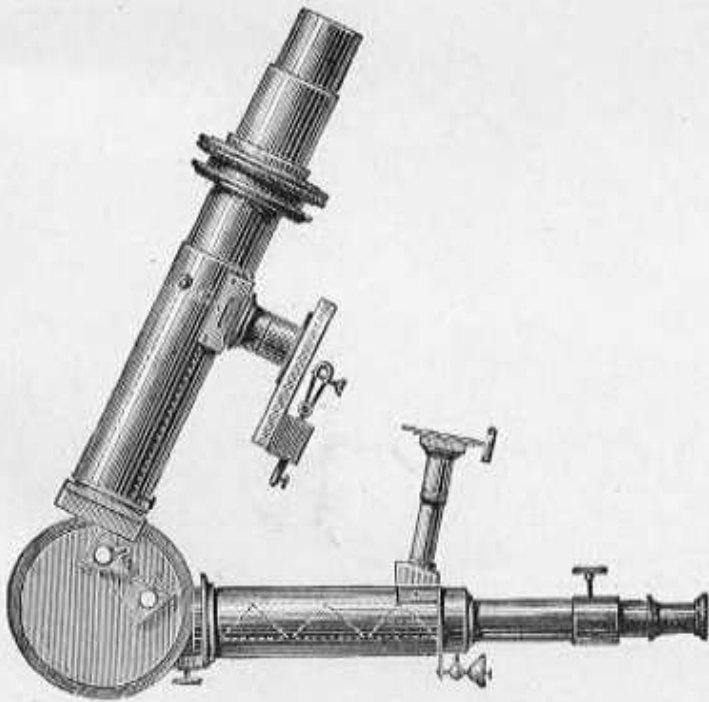

No. 3.
Catalog No. 183.

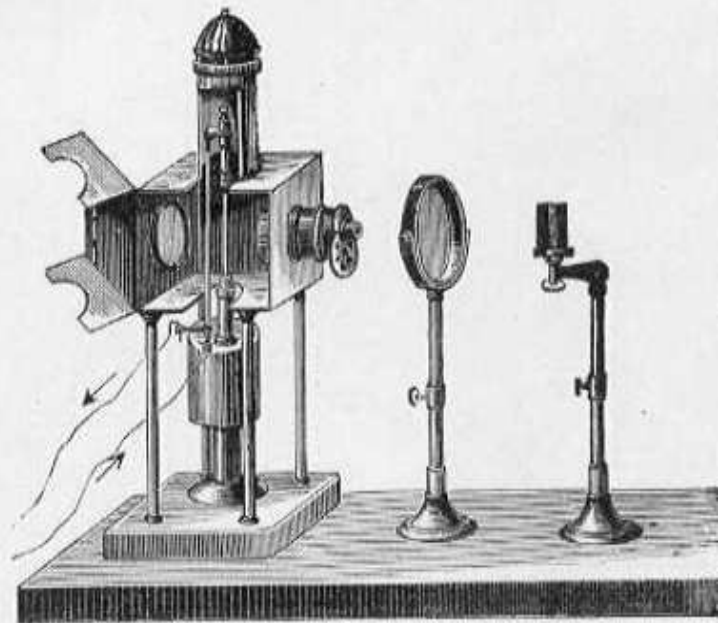

No. 4.
Catalog No. 205.

Tab. XVIII.

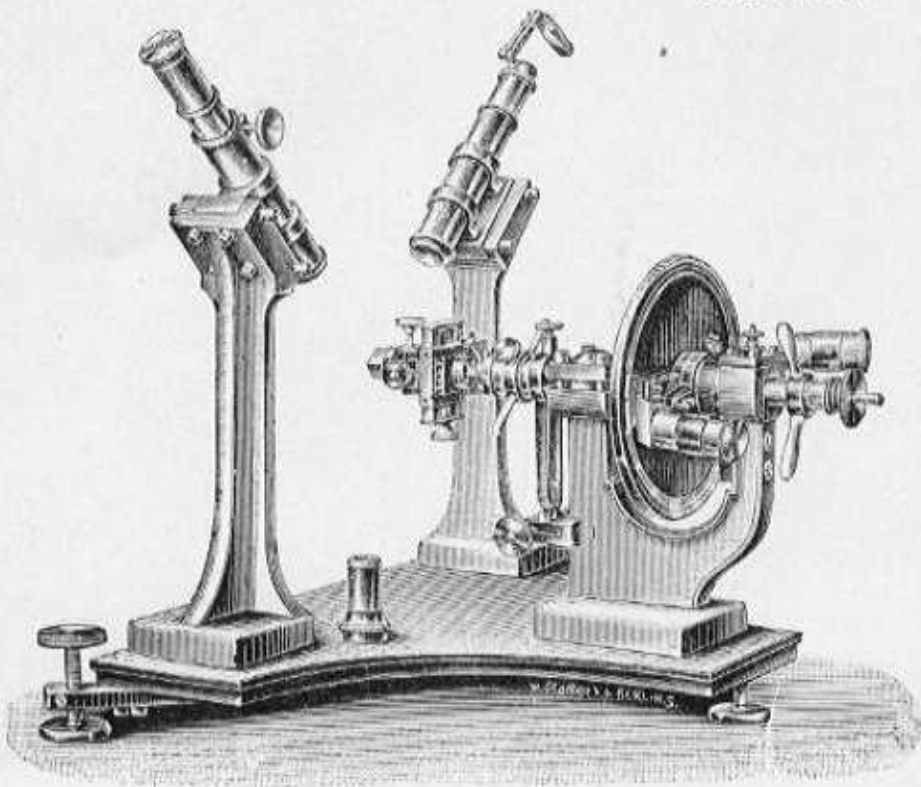

No. 1.
Catalog No. 221.

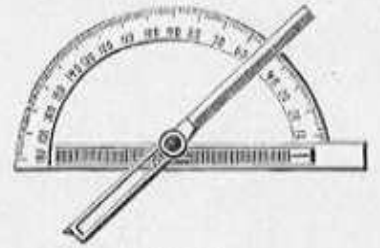

No. 3.
Catalog No. 224.

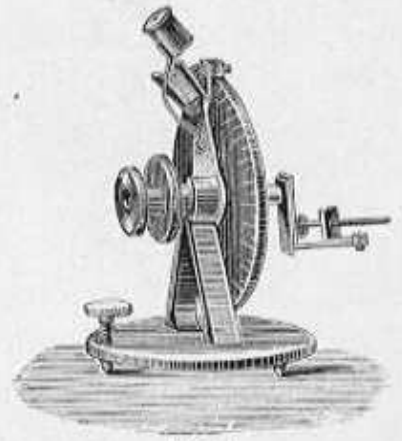

No. 4.
Catalog No. 223.

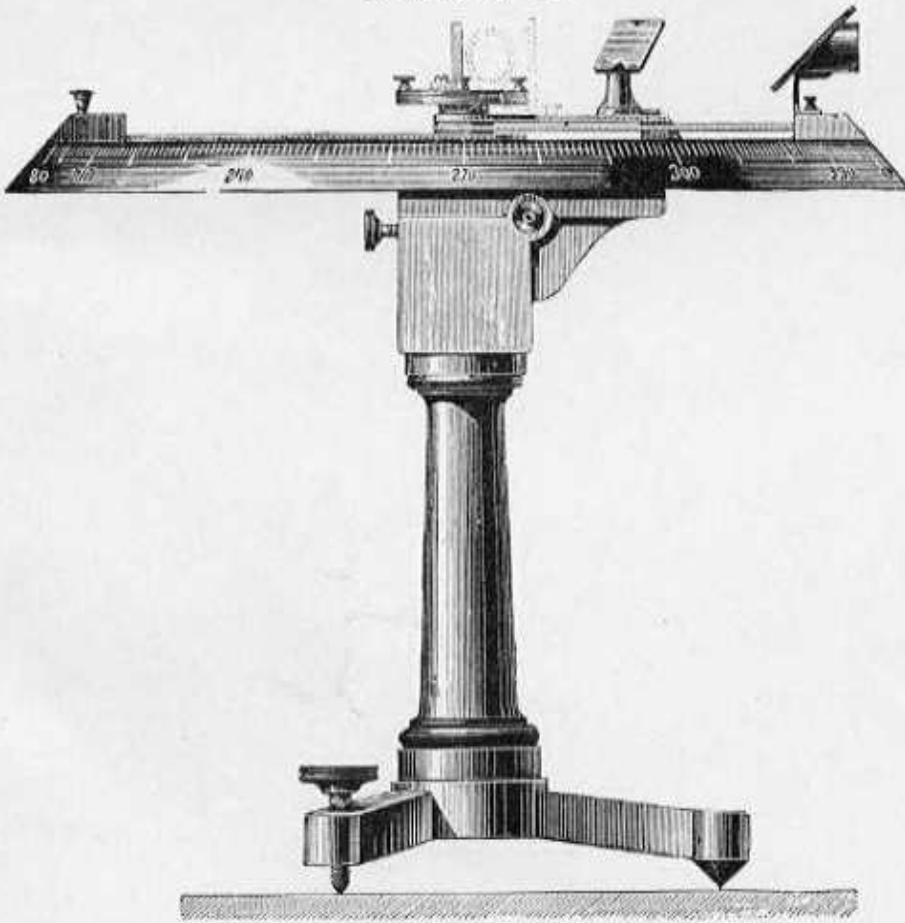

No. 2.
Catalog No. 220.

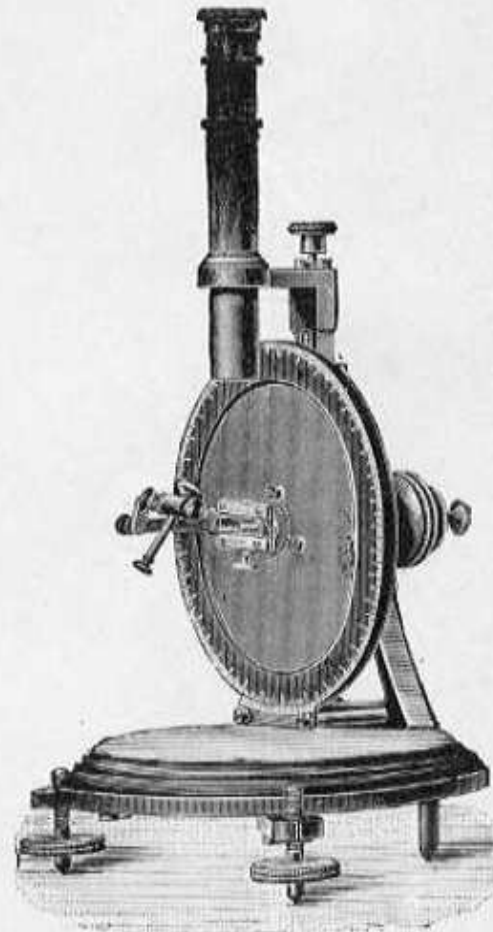

No. 5.
Catalog No. 222.

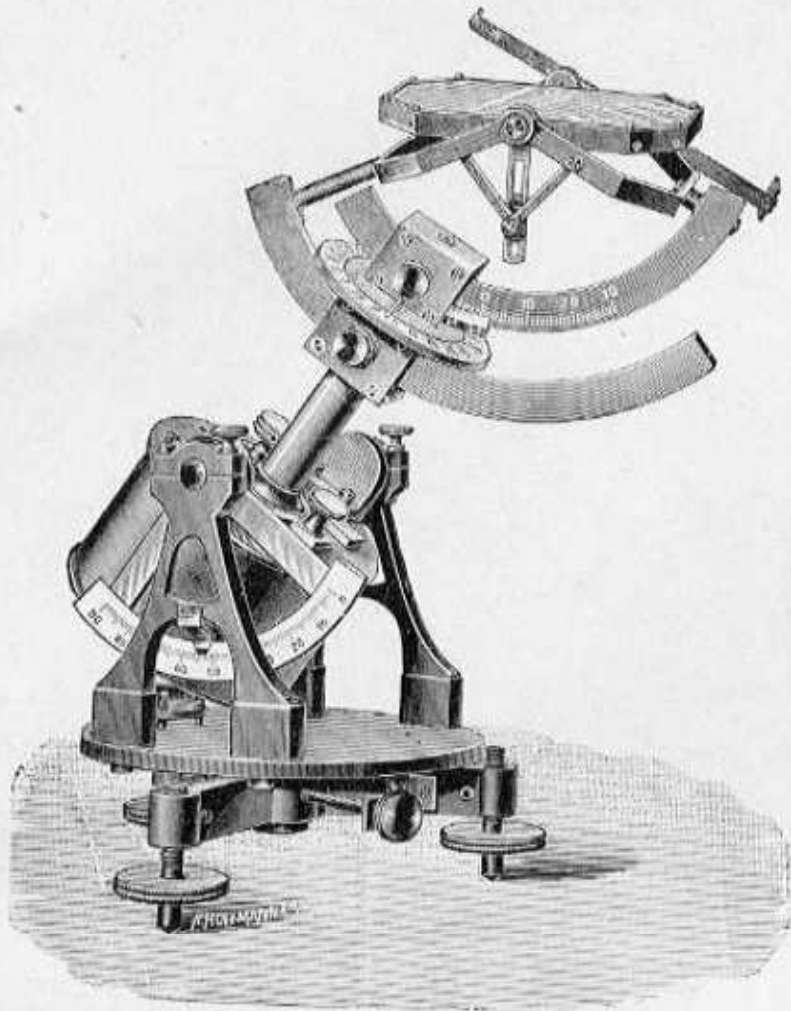

No. 1.
Catalog No. 225.

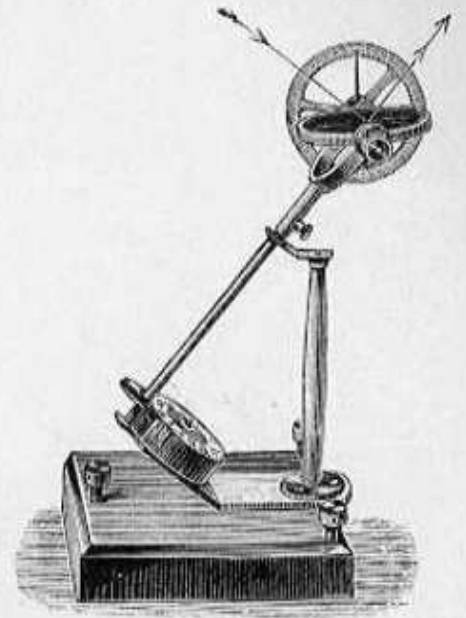

No. 3.
Catalog No. 227.

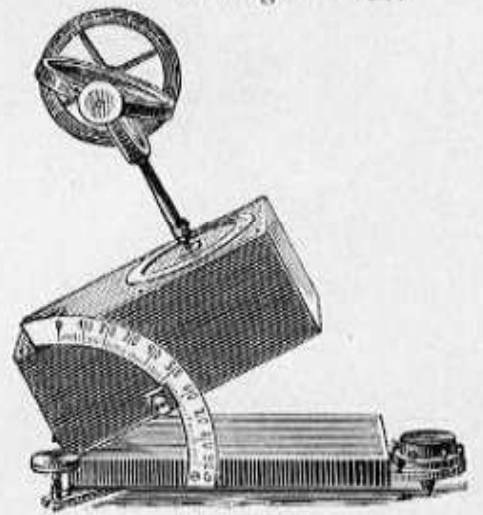

No. 4.
Catalog No. 228.



No. 2.
Catalog No. 226.

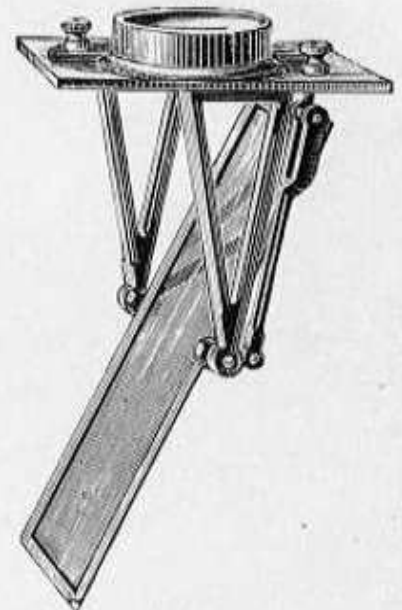

No. 5.
Catalog No. 231.

Tab. XX.

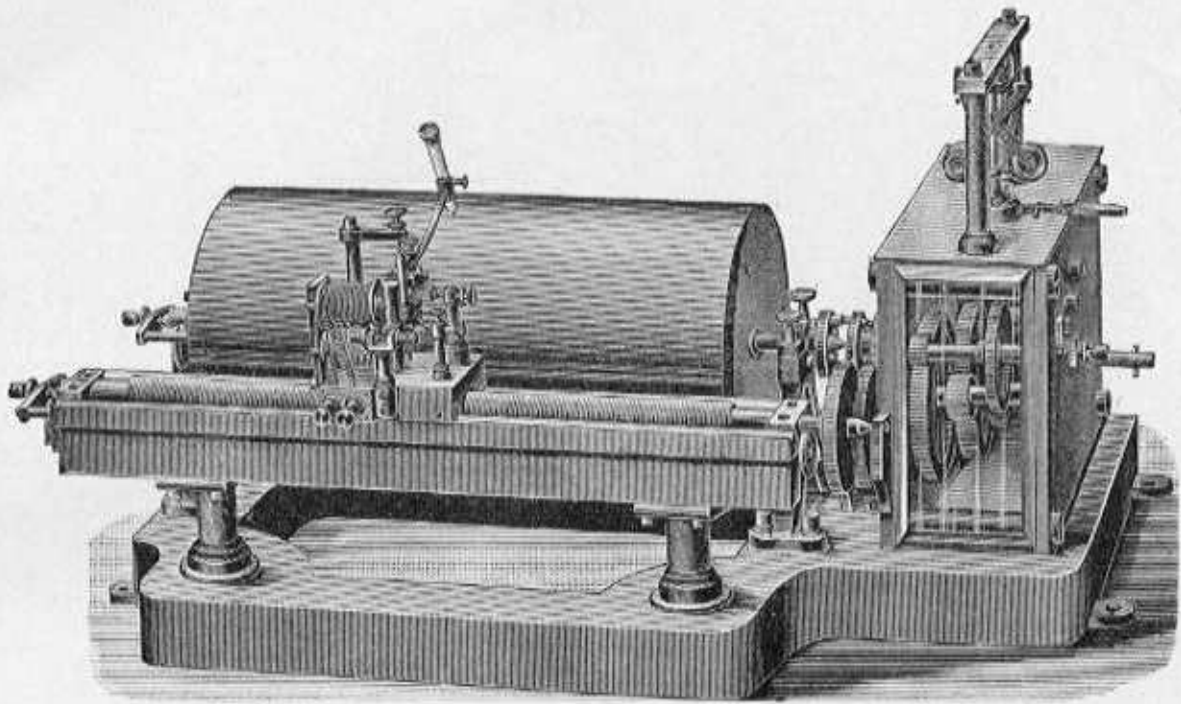

No. 1.
Catalog No. 378.

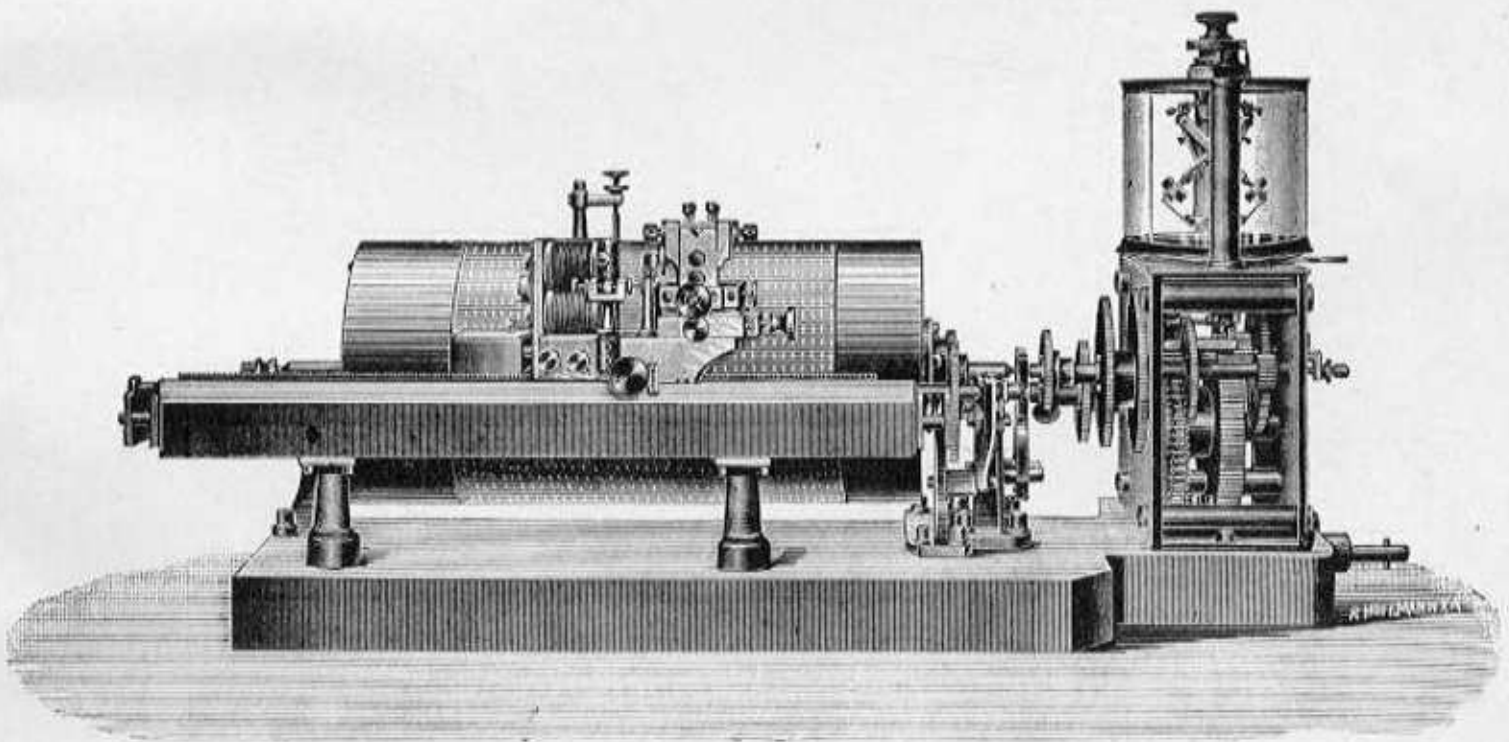

No. 2.
Catalog No. 379.

Tab. XXI.

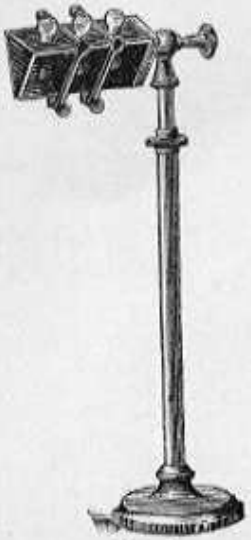

No. 1.
Catalog No. 302.



No. 2.
Catalog No. 303.



No. 3.
Catalog No. 309.



No. 4.
Catalog No. 299.



No. 5.
Catalog No. 307.

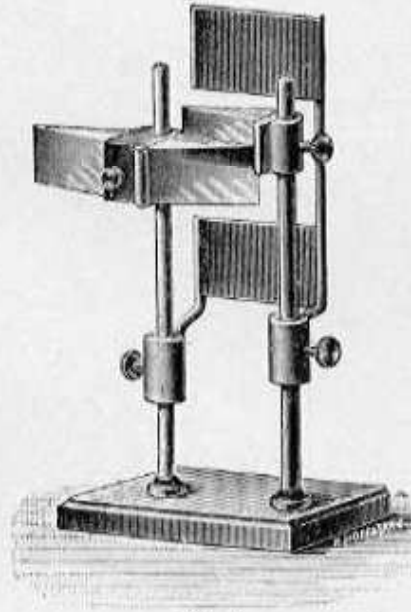

No. 6.
Catalog No. 312.

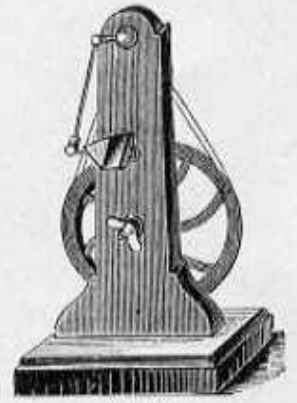

No. 7.
Catalog No. 311.

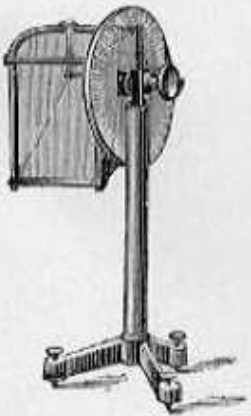

No. 8.
Catalog No. 301.

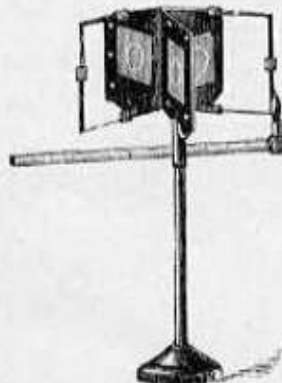

No. 9.

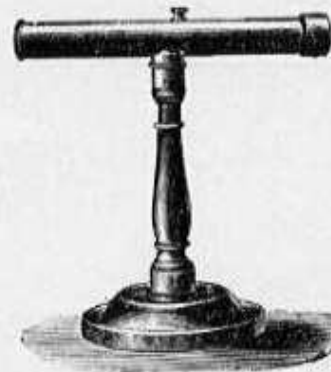

No. 10.



No. 11.

Tab. XXII.

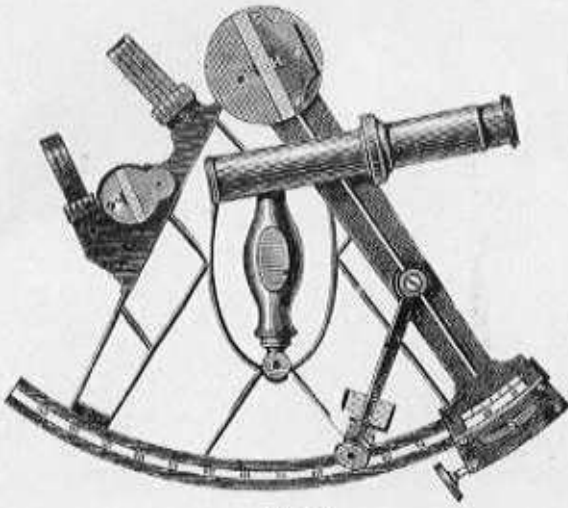

No. 1.
Catalog No. 127.

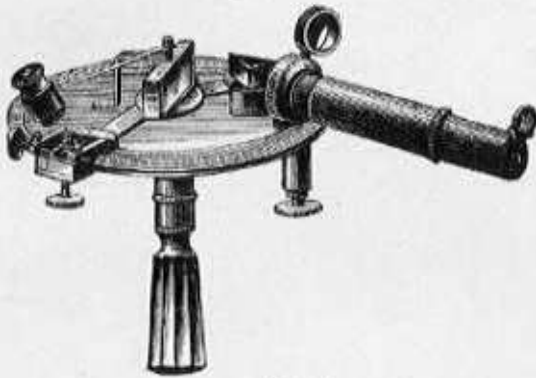

No. 2.
Catalog No. 133.



No. 8.
Catalog No. 260.

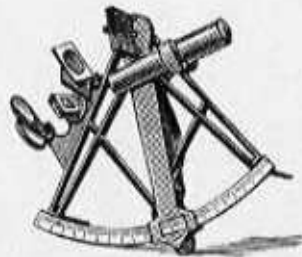

No. 6.
Catalog No. 129.



No. 7.
Catalog No. 287.



No. 9.
Catalog No. 263.

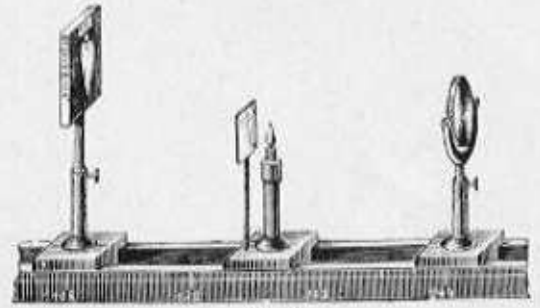

No. 3.
Catalog No. 270.

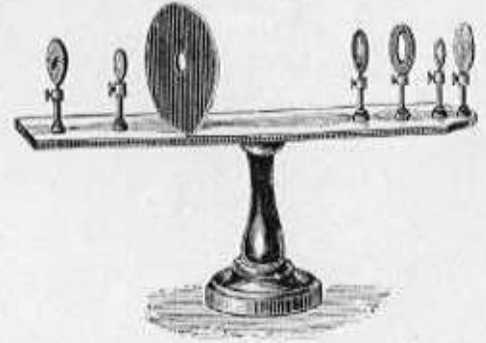

No. 4.
Catalog No. 296.

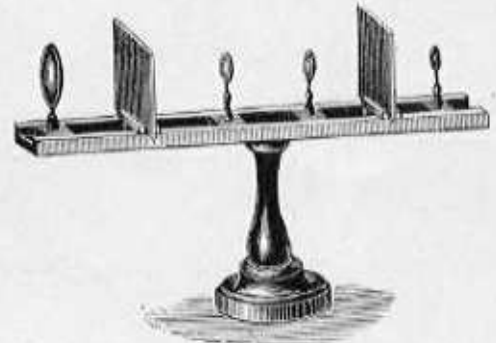

No. 5.
Catalog No. 292.

Tab. XXIII.

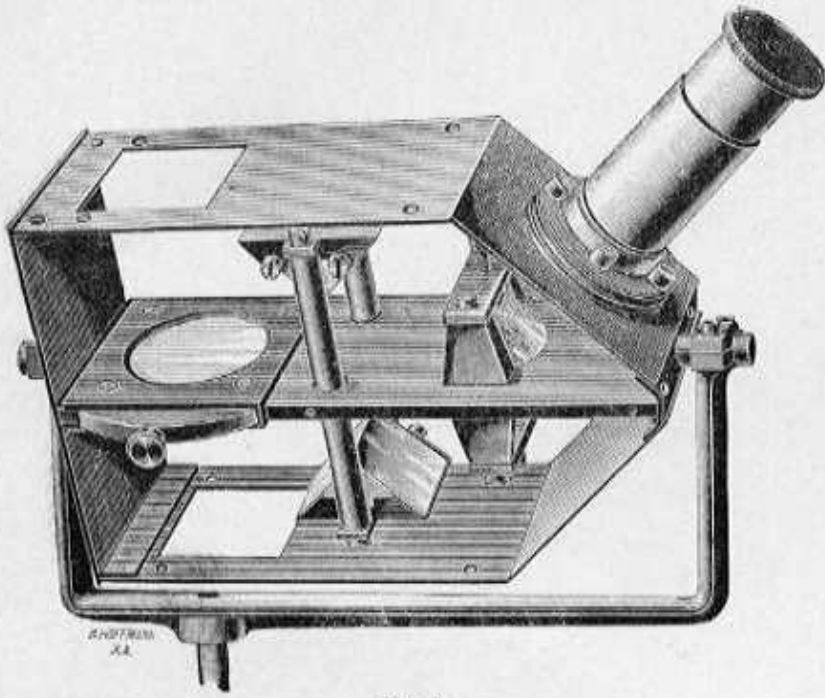

No. 1.
Catalog No. 259.

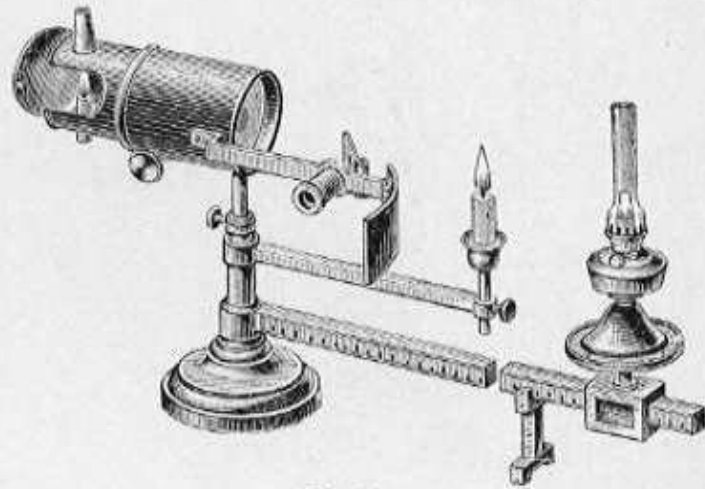

No. 2.
Catalog No. 264.

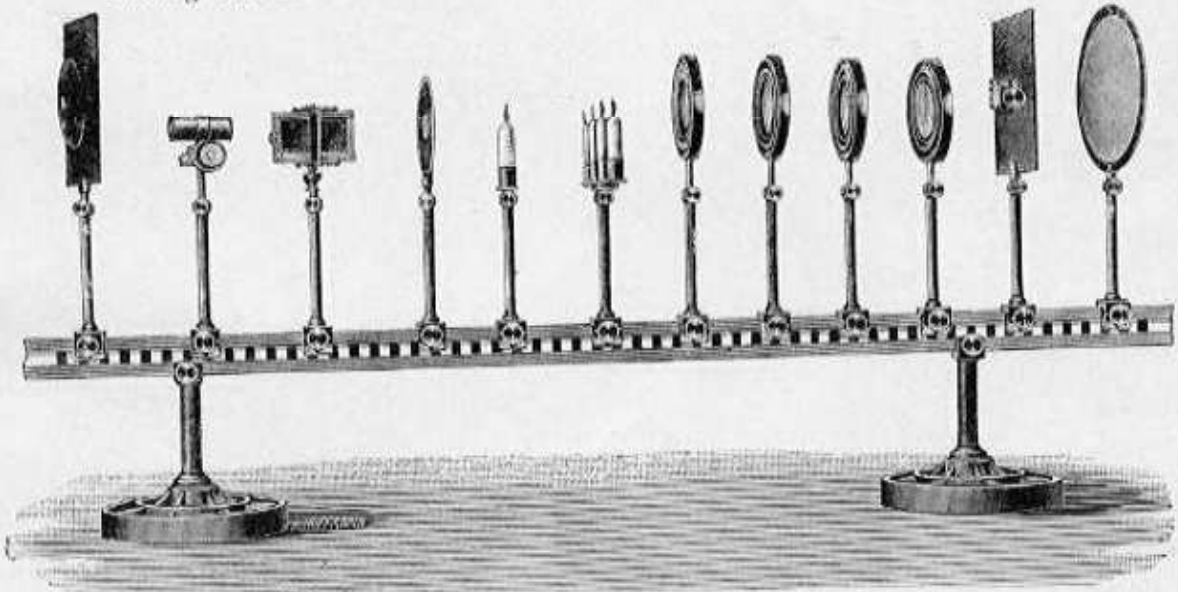

No. 3.
Catalog No. 267.

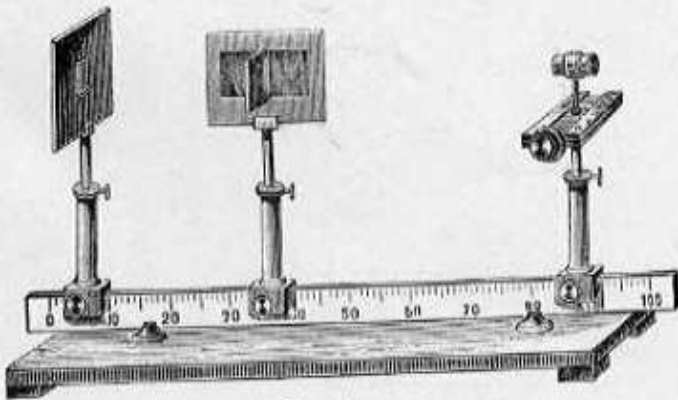

No. 4.
Catalog No. 271.

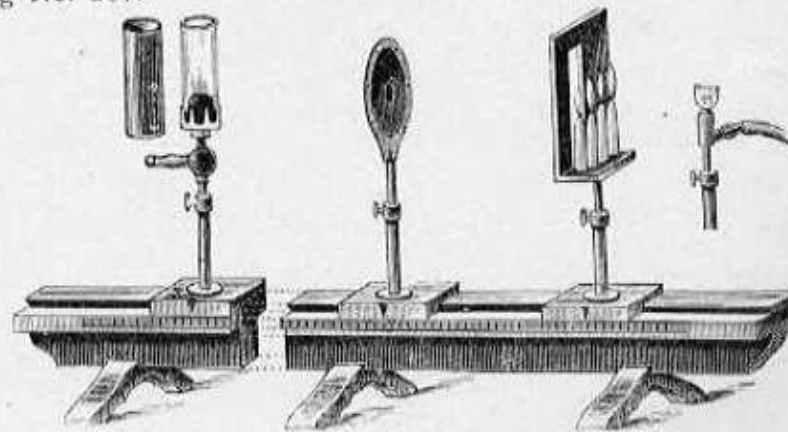

No. 5.
Catalog No. 268.

Tab. XXIV.

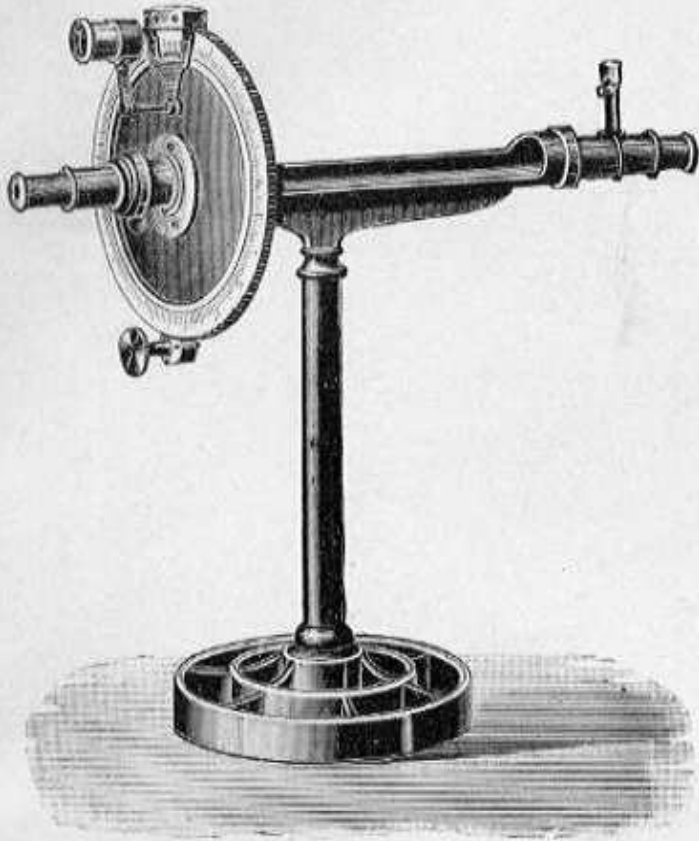

No. 1.
Catalog No. 331.



No. 5.
Catalog No. 333.

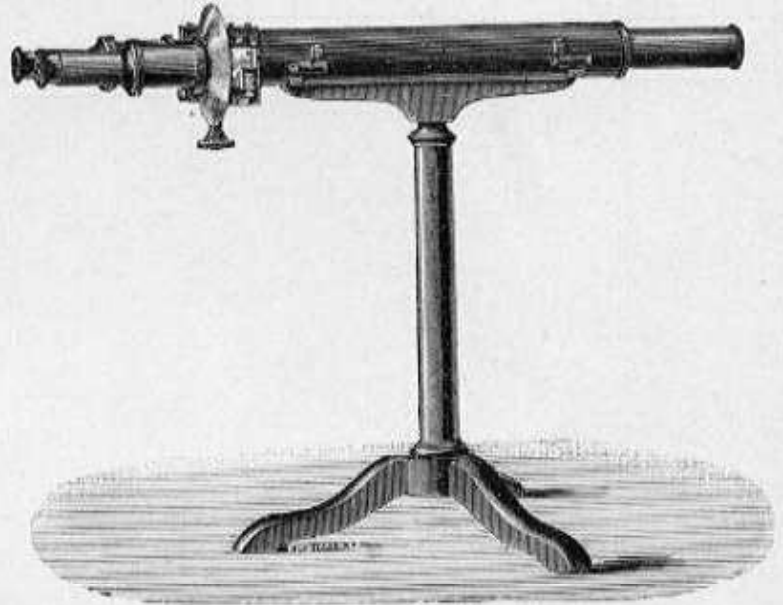

No. 3.
Catalog No. 343.

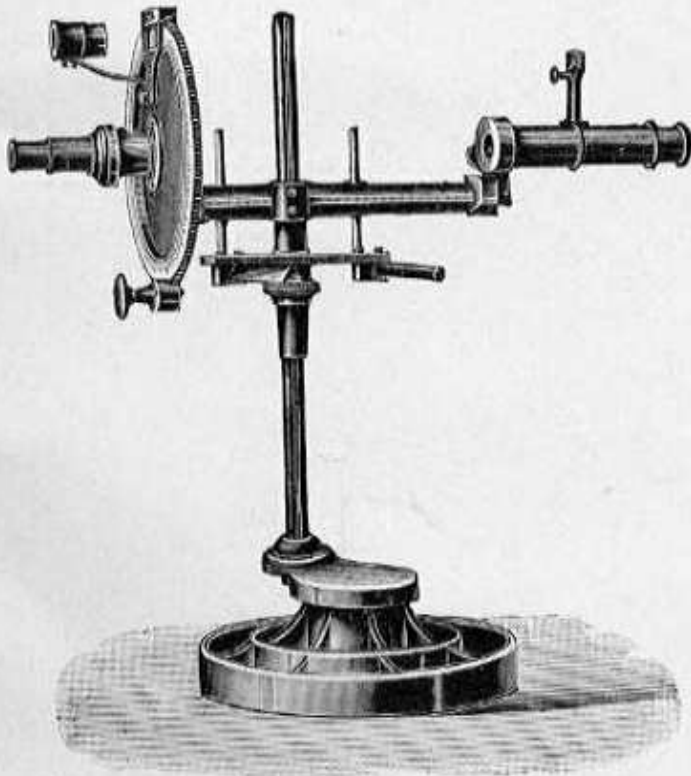

No. 2.
Catalog No. 329.

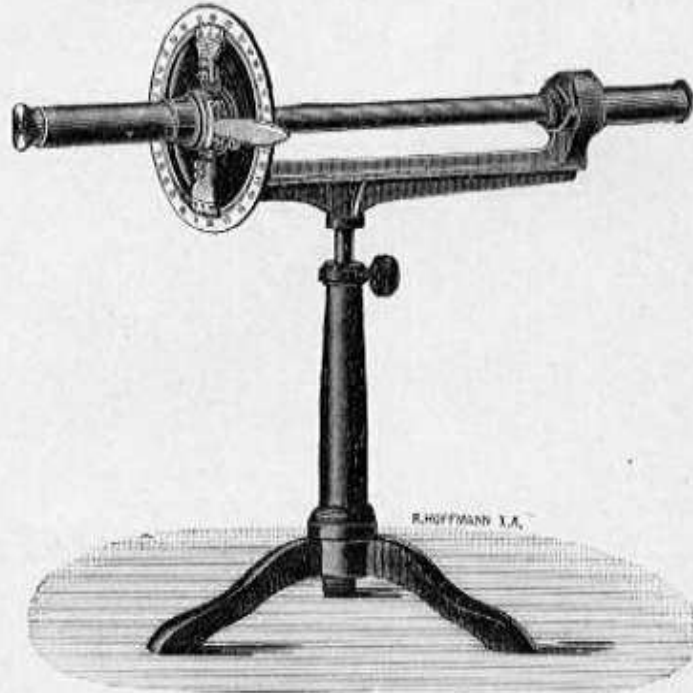

No. 4.
Catalog No. 332.

Tab. XXV.

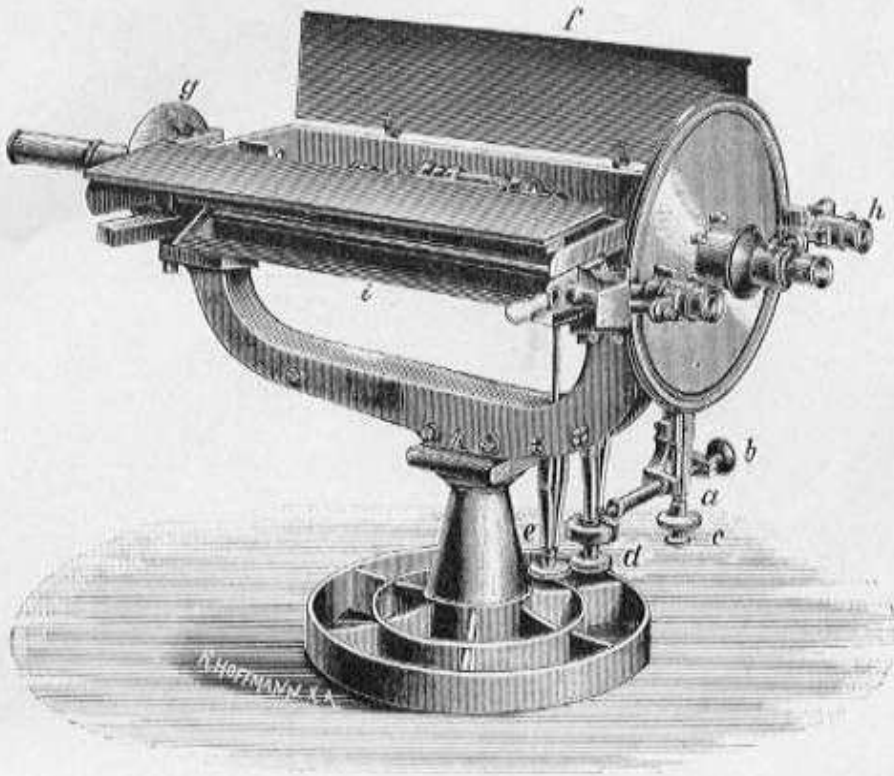

No. 1.
Catalog No. 325.

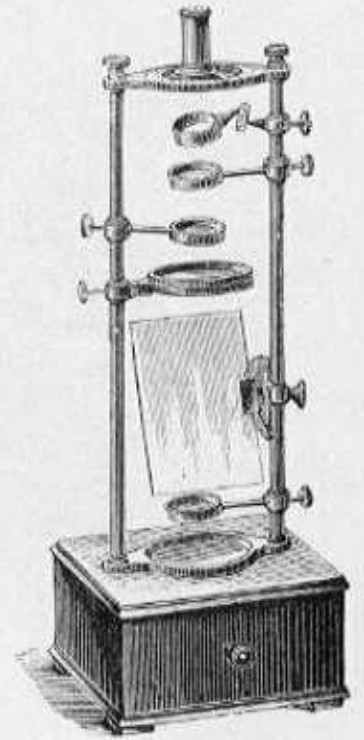

No. 2.
Catalog No. 362.

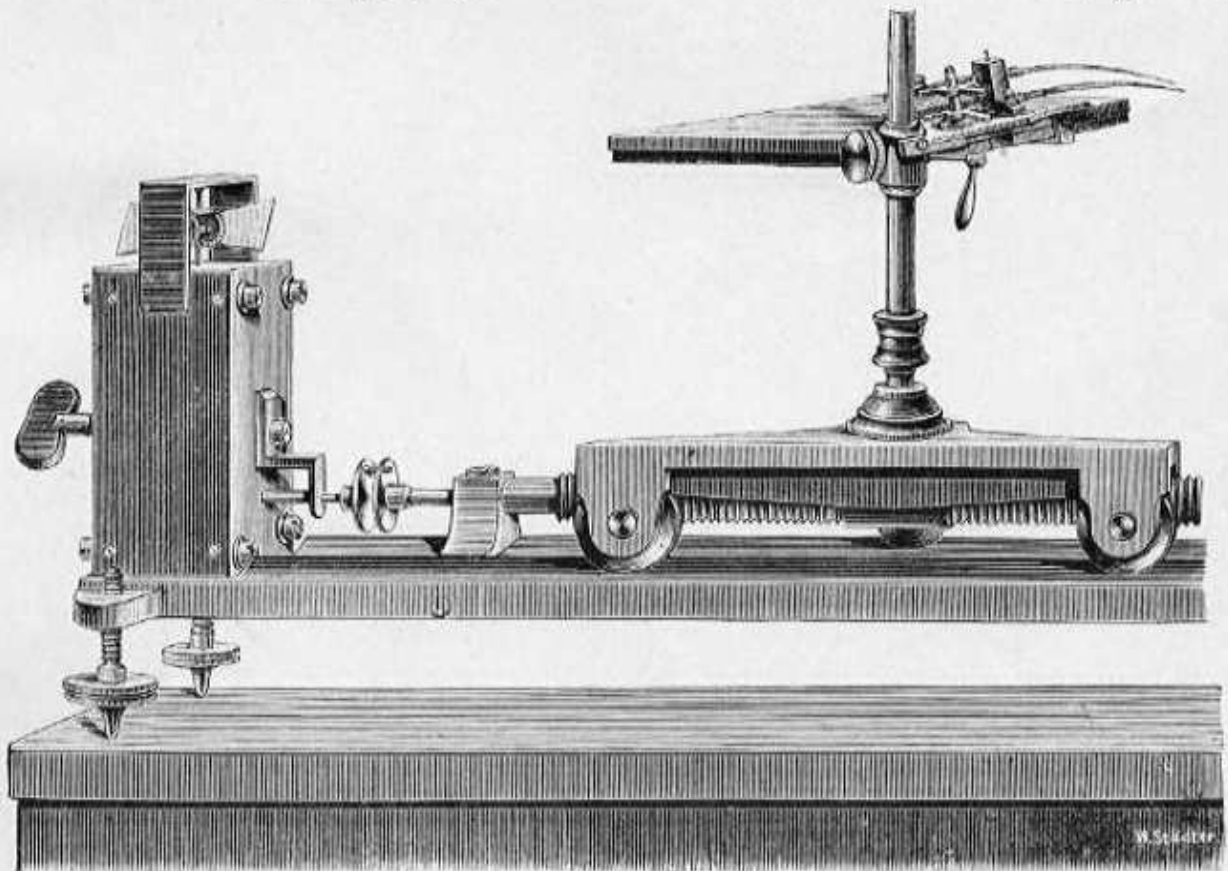

No. 3.
Catalog No. 395.

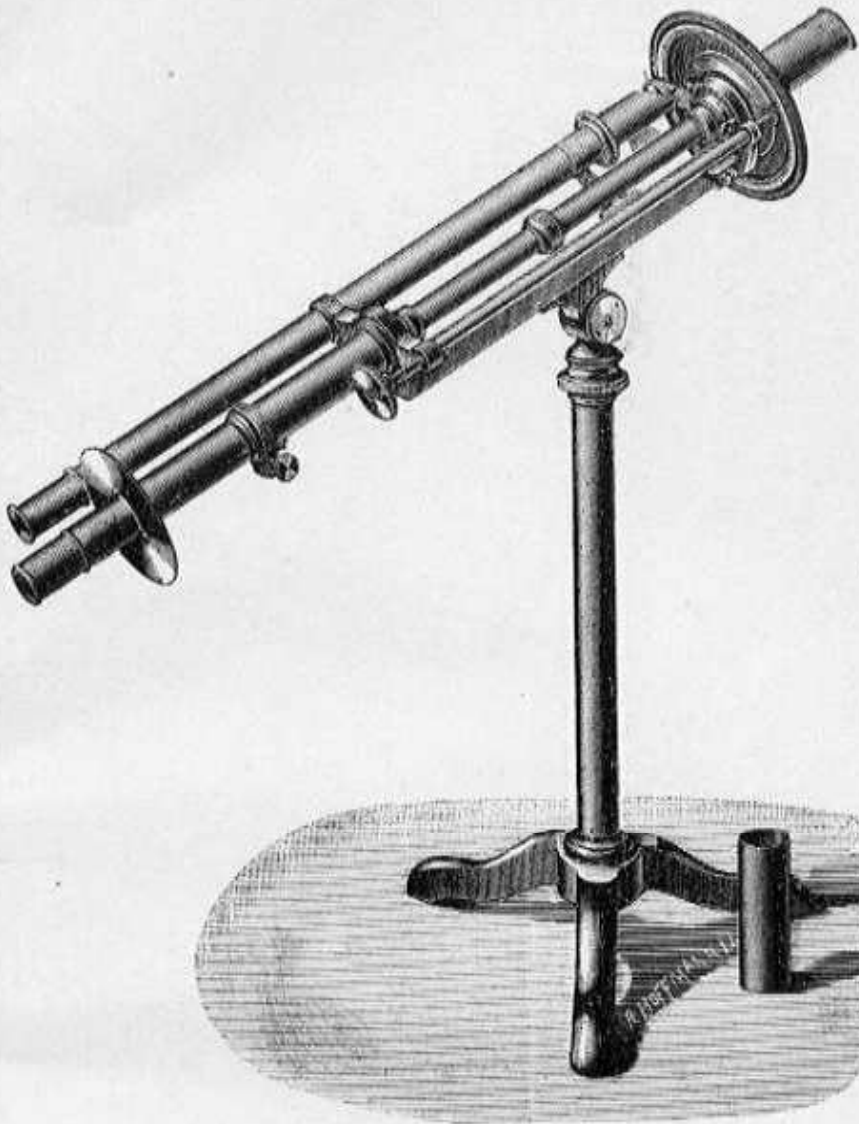

No. 1.
Catalog No. 339.

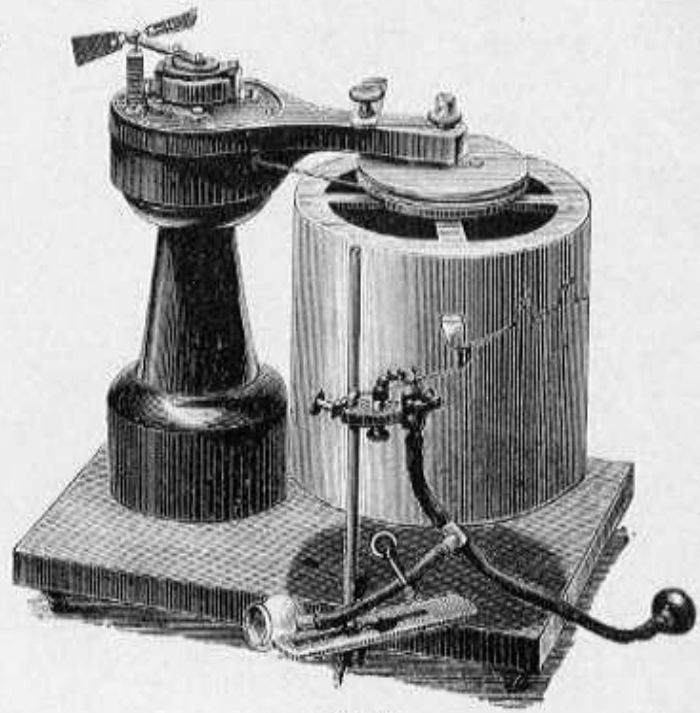

No. 2.
Catalog No. 391.

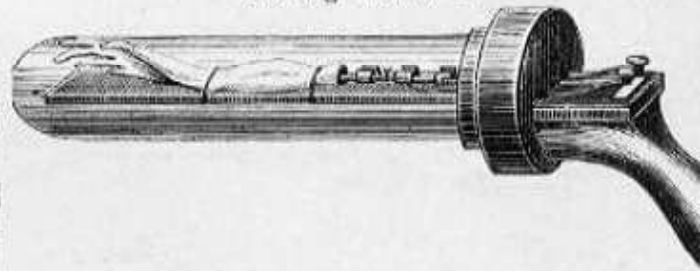

No. 3.
Catalog No. 398.

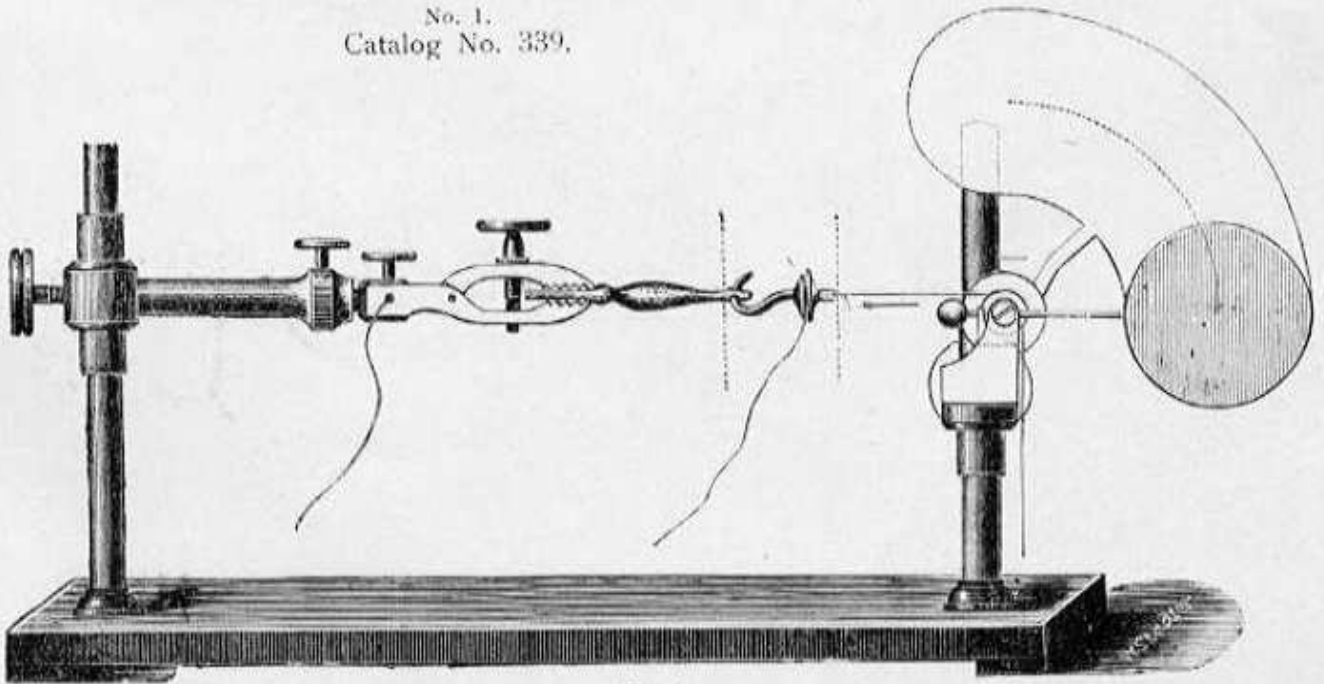

No. 4.
Catalog No. 394.

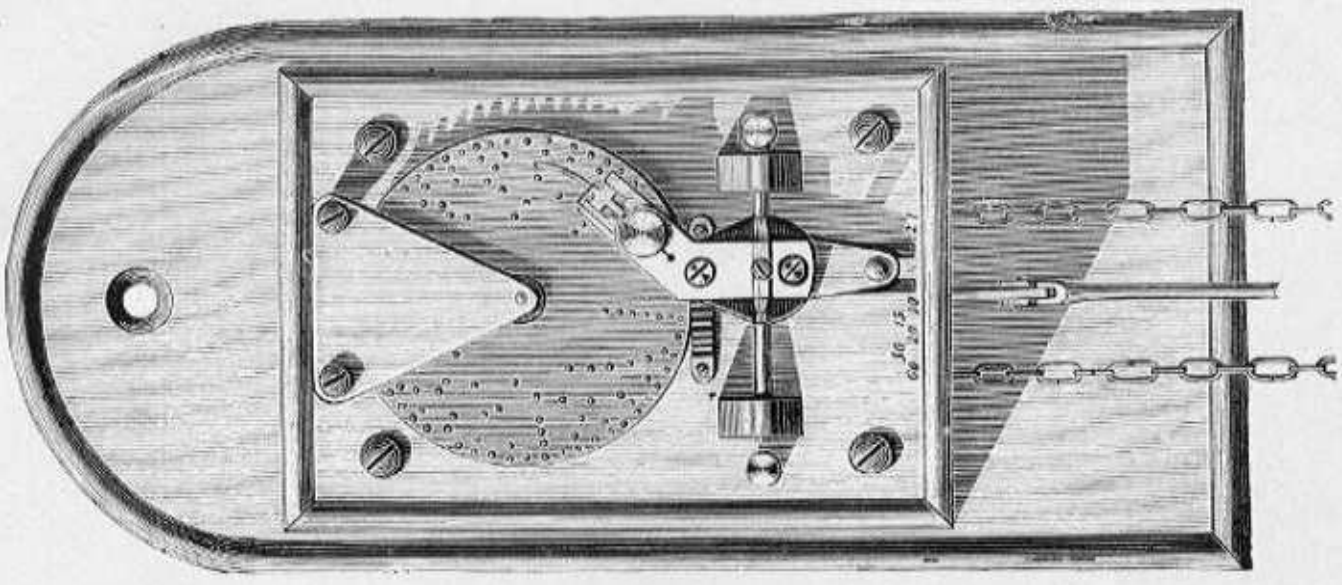

No. 2.
Catalog No. 397.

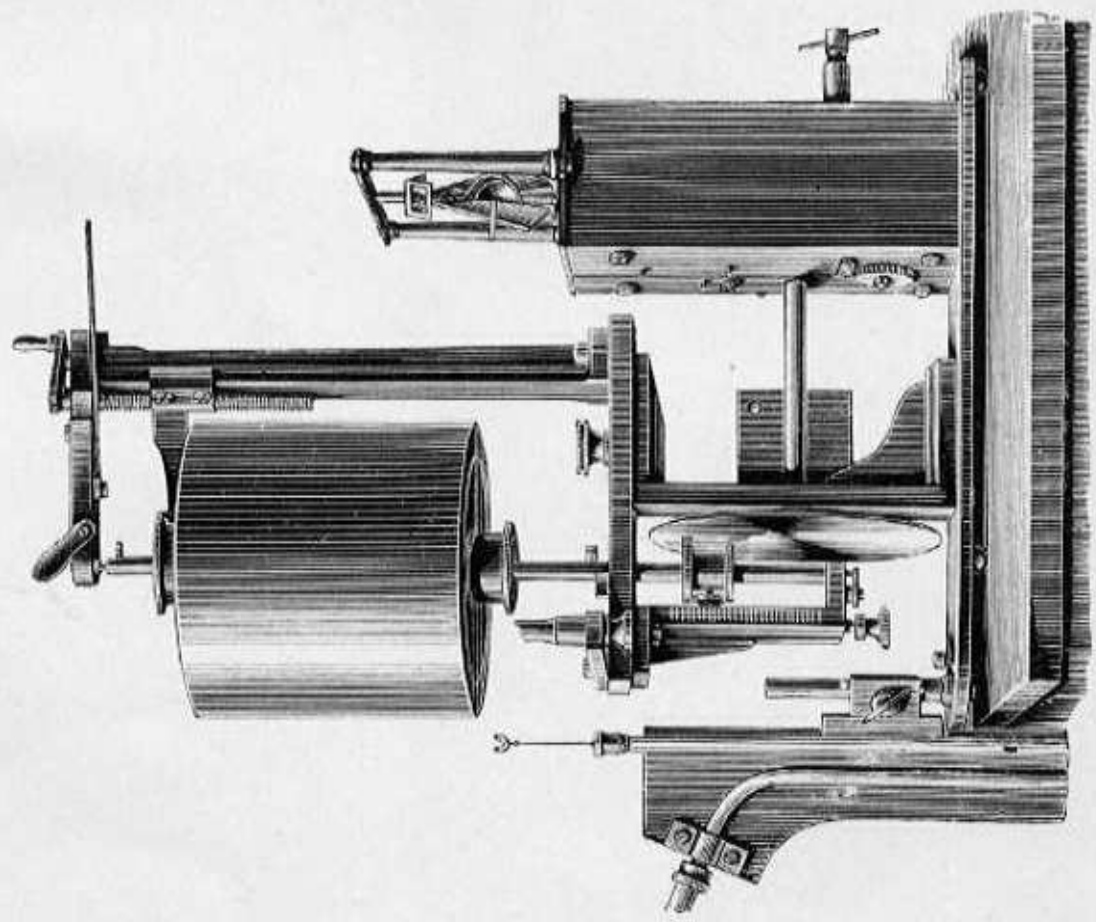

No. 1.
Catalog No. 390.

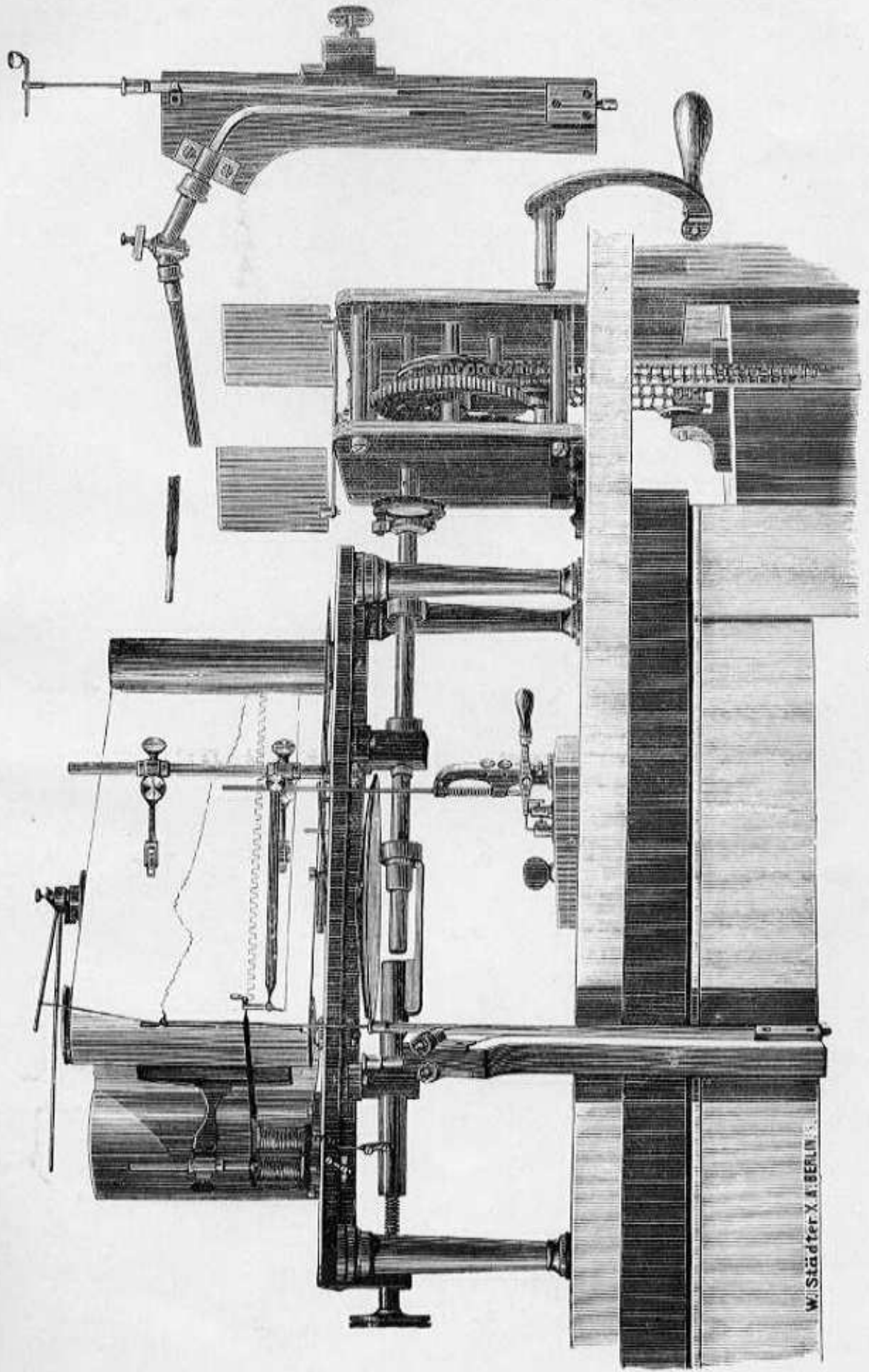

W. Stöcker X. A. BERLIN

Tab. XXIX.

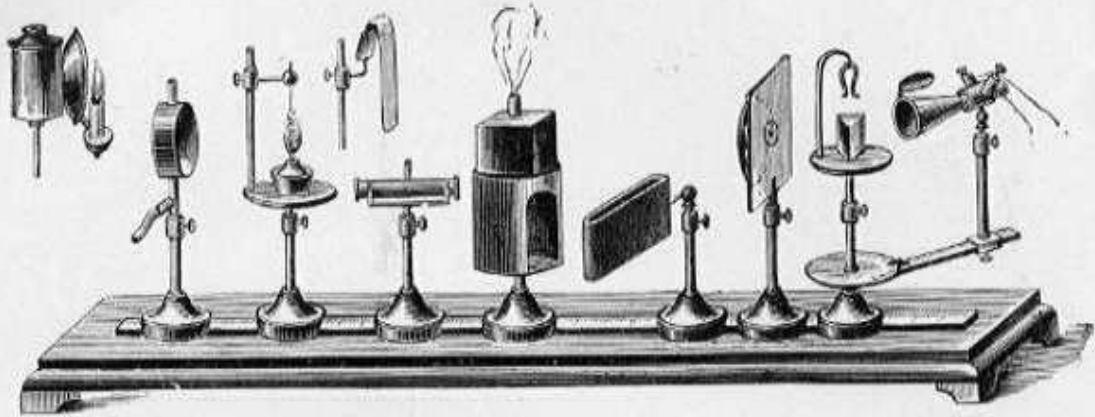

No. 1.
Catalog No. 412.



No. 2.
Catalog No. 403.

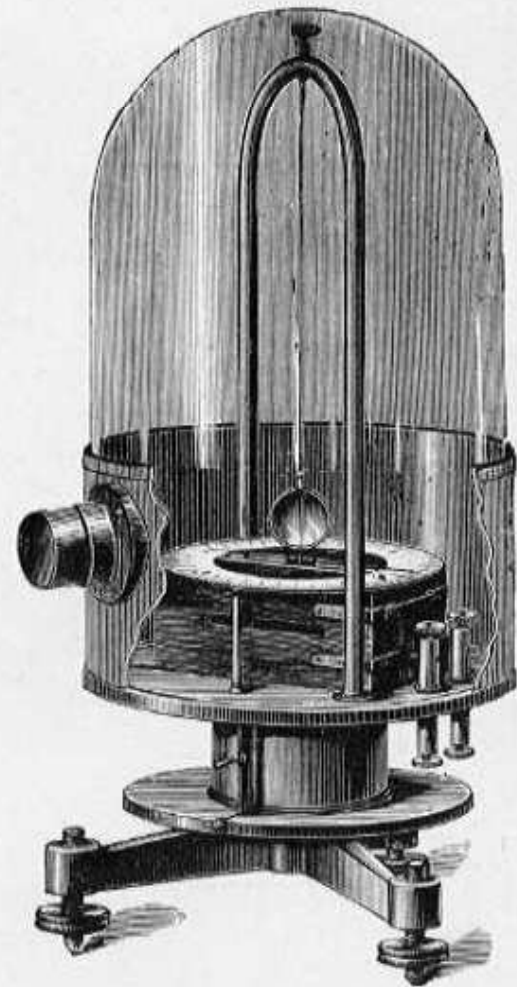

No. 3.
Catalog No. 405.

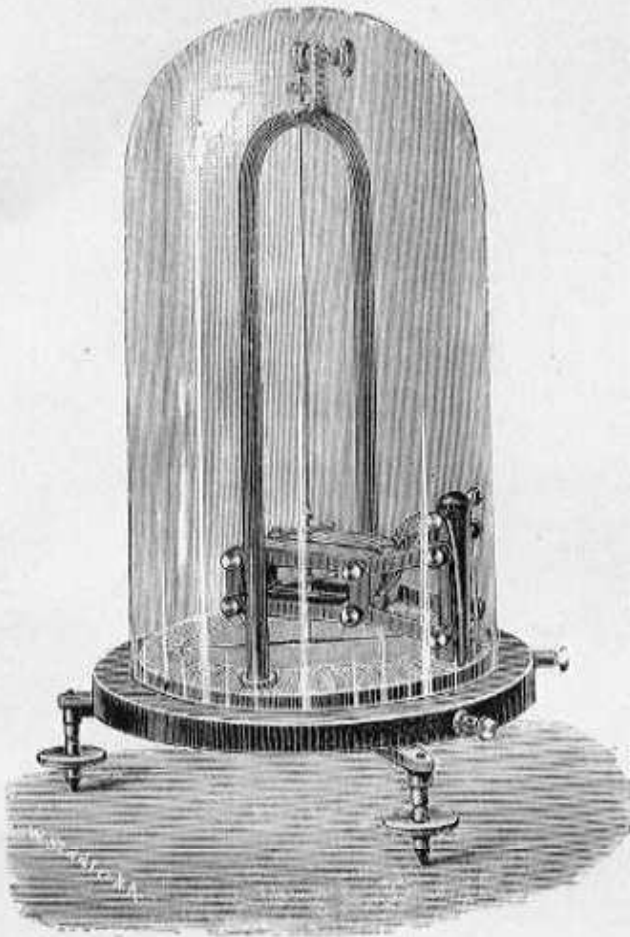

No. 1.
Catalog No. 401.

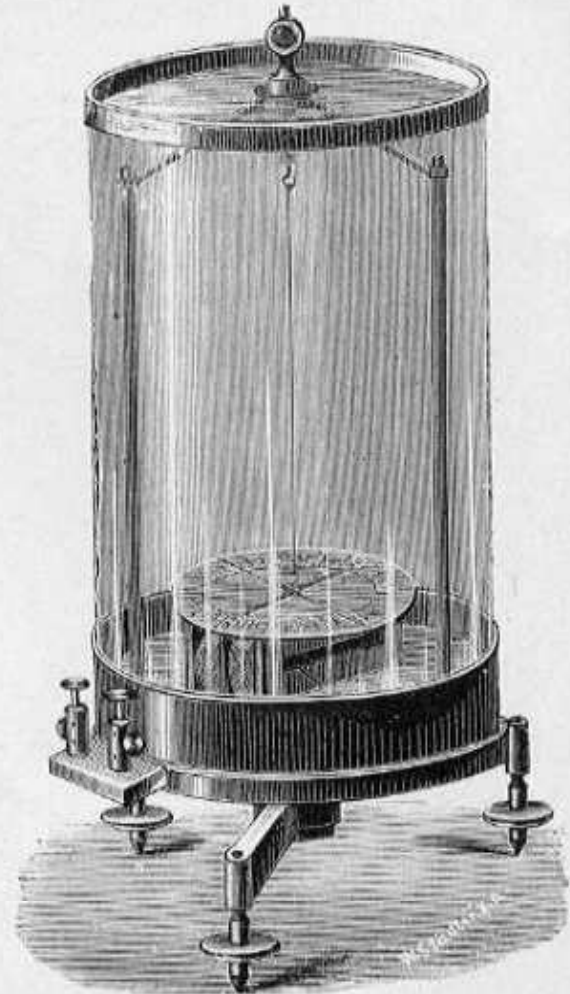

No. 2.
Catalog No. 404.

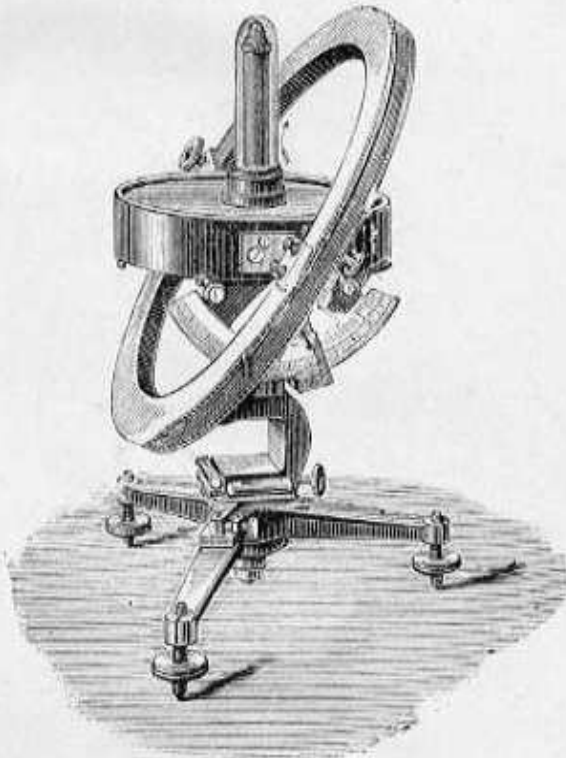

No. 3.
Catalog No. 411.

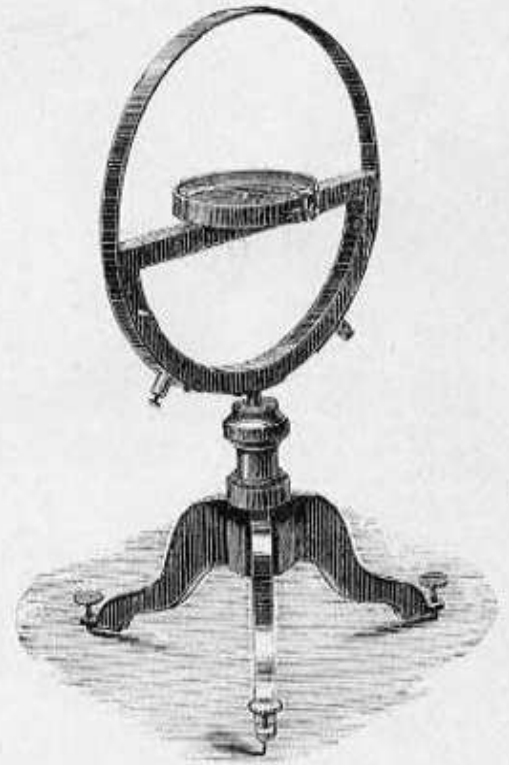

No. 4.
Catalog No. 409.

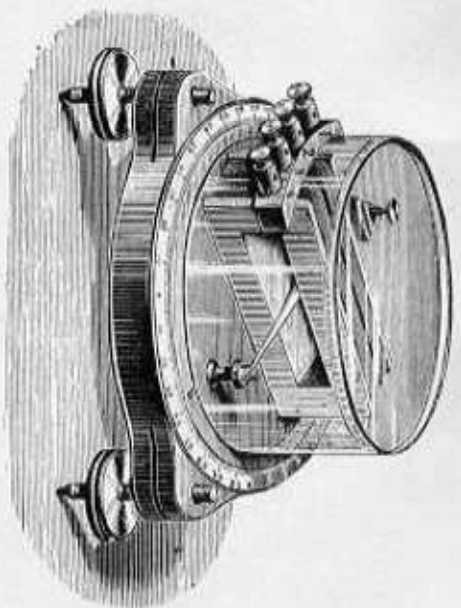

No. 3.
Catalog No. 406.

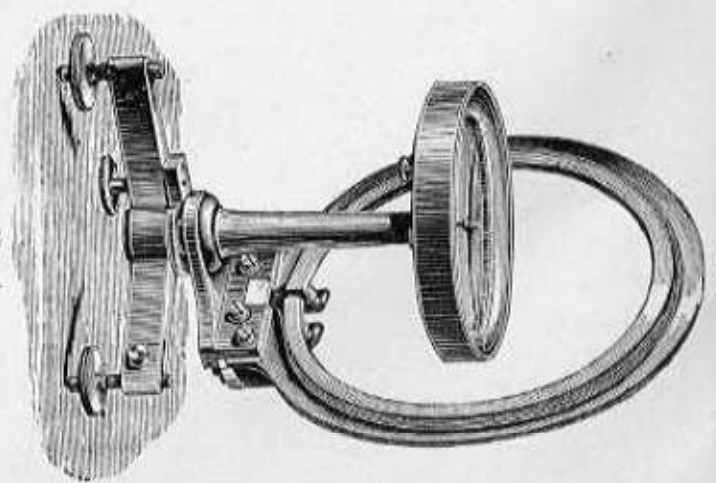

No. 4.
Catalog No. 410.

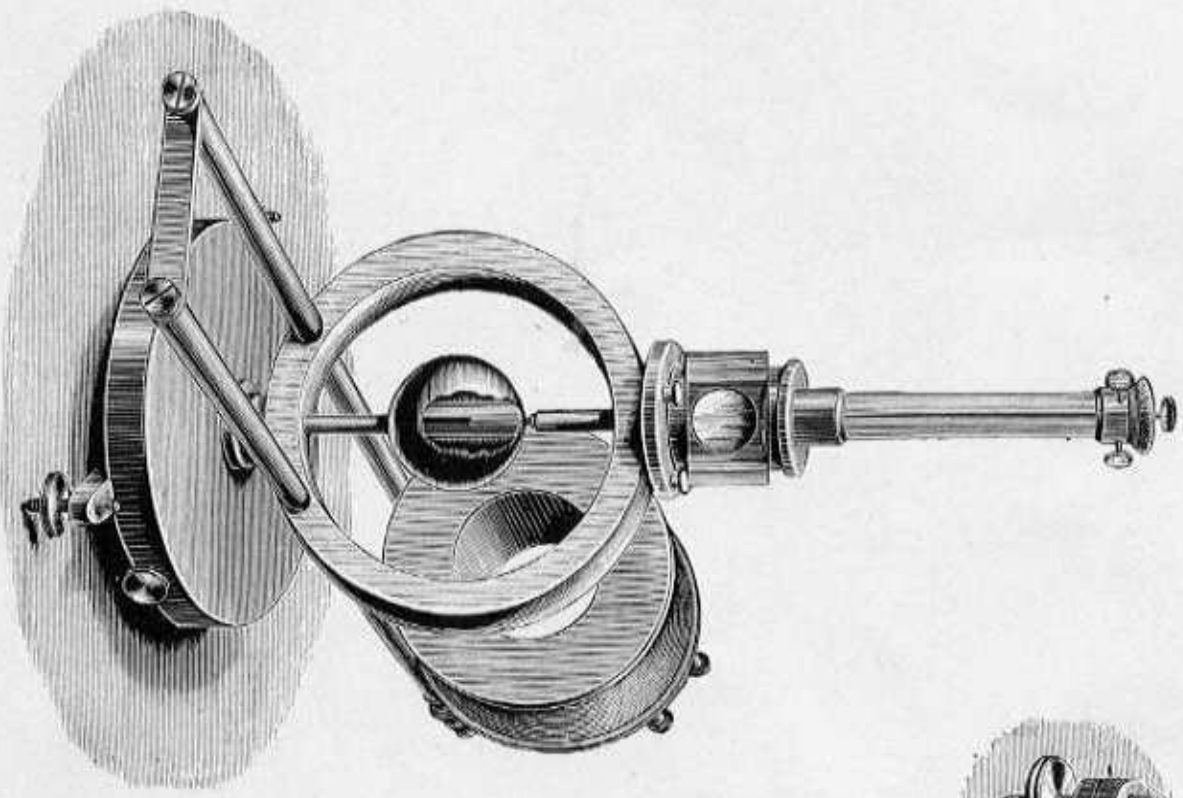

No. 1.
Catalog No. 408.

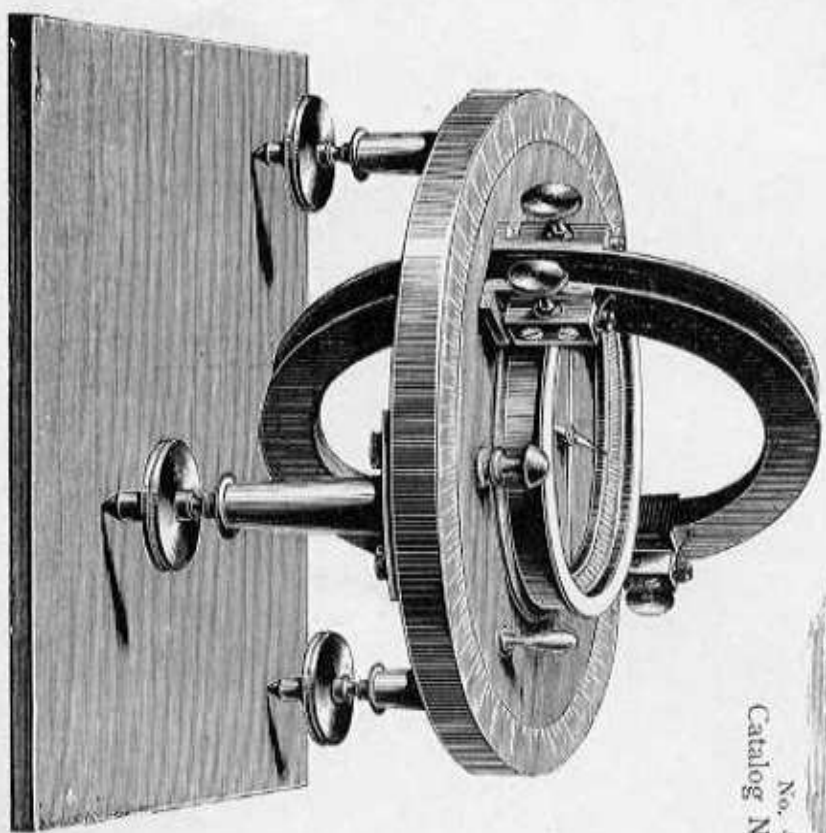

No. 2.
Catalog No. 407.

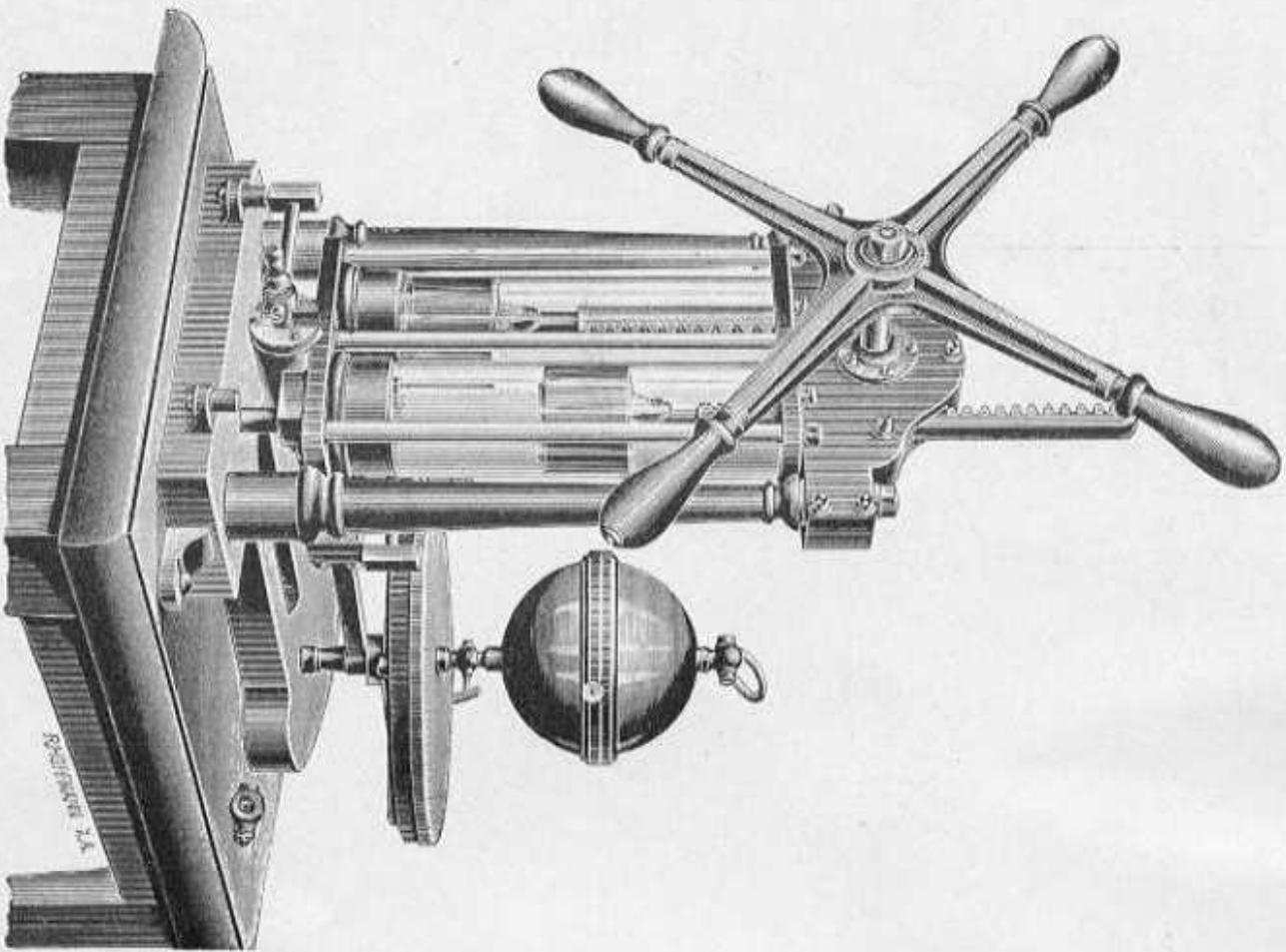

No. 1.
Catalog No. 417.

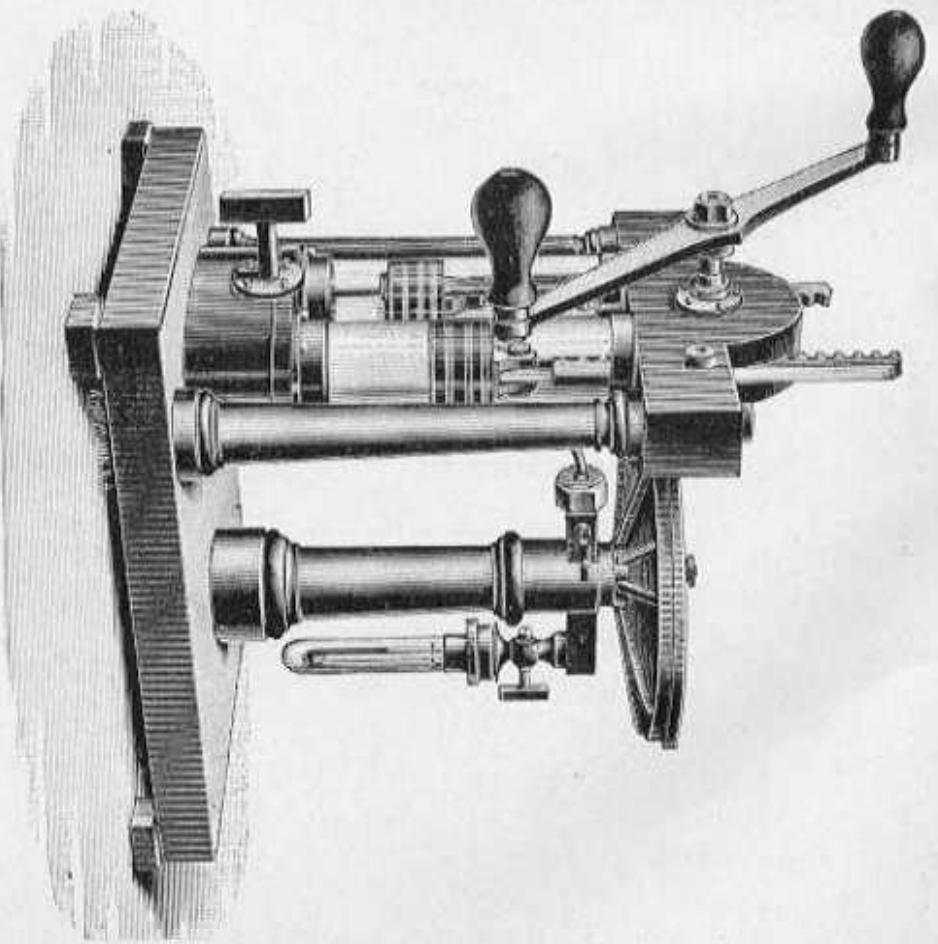

No. 2.
Catalog No. 416.

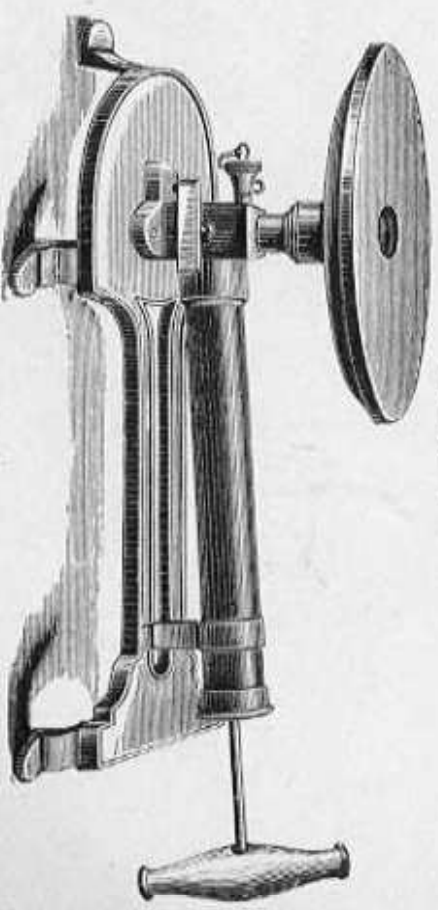

No. 3.
Catalog No. 420.

